

# PRODUCT CATALOG

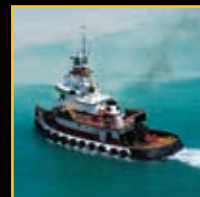
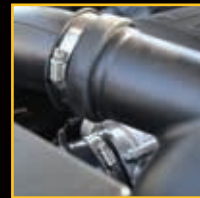
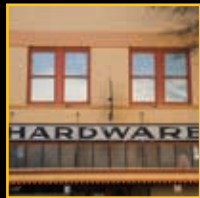

PROVEN DESIGNS, BILLIONS OF TIMES | IDEALTRIDON.COM

# TABLE OF CONTENTS

<b>About Us</b> .....	<b>3</b>
<b>Engineering &amp; Quality</b> .....	<b>4</b>
<b>How to Use this Catalog</b> .....	<b>6</b>
<b>Products</b>	
SmartSeal® (37215).....	8
WaveSeal <sup>360</sup> ® (36003).....	8
SmartSeal® HD (38215).....	8
Micro-Gear® (359, 62M, 62P, 52M).....	10
Fuel Injection (52F).....	11
1/2" Hy-Gear® (67-4, 67-1, 67-5, 57-0, 52-0, 67-6).....	12
9/16" Hy-Gear® (63-4, 68-0, 50-0, 64-0).....	14
Non-Perforated (9mm 533xx, 12mm 534xx).....	16
Band & Buckle (60080, 60081, 60082).....	18
Pinch/Crimp Clamp & Tool (61).....	19
Combo-Hex® (54-0).....	20
Military Worm Drive (632).....	20
Surelock Quick Engage (48, 49).....	21
Snaplock® Quick Release (56-0, 500, 58-0, 550).....	22
Wraplock® (59-0).....	24
Lox-On® (69-0).....	24
Turn-Key® (5Y/6Y).....	25
Flexible Hose Clamp Driver (9999V).....	25
Lined (65E, 615, 53-0, 67M).....	26
Pow'r-Gear® (60, 6P, 6L, 6M, 6X).....	28
T-Bolt - Min Dia. (30010, 30011, 30020, 30021).....	30
T-Bolt - Nom. Dia. (30050, 30051).....	32
Spring-Loaded T-Bolt (30030).....	33
V-Bands (24000).....	34
Clamp Safety Caps.....	35
Flex-Gear® (43, 47, 41, 45).....	36
<b>Merchandisers &amp; Packaging</b> .....	<b>38</b>
130 PC Rack.....	38
Clamp Shaped Racks.....	38
SmartSeal® Profit Center.....	40
25 PC Contractor Bags.....	40
10 PC Assortment Bags.....	41
Blister Product Line.....	41
<b>Product Cross Reference Guide</b> .....	<b>43</b>

**Ideal Clamp Products, Inc.**  
**Global Headquarters**  
 8100 Tridon Drive  
 Smyrna, TN USA 37167-6603  
 T: 800.251.3220 615.459.5800  
 F: 615.223.1550

**Ideal Clamp Products, Inc.**  
 7765 Padre Island Hwy. Ste 500  
 Brownsville, TX USA 78521  
 T: 956.838.5488 F: 956.838.5489

**Ideal Clamp Products, Inc.**  
 Western Regional DLVR/0305  
 1424 Raymond Ave South  
 Fullerton, CA 92831  
 T: 800.251.3220 F: 615.223.1550

**Auto Industrial de Parts, S.A. De C.V.**  
 Lic. Albino Hernández No. 7 Pte.  
 H. Matamoros, Tamaulipas, Mexico 87340  
 T: +52.868.810.8310 F: +52.868.813.5668

**Ideal Internacional S.A.**  
 Mariano Matamoros #276  
 Col. Tlalpan, C.P. 14000  
 México D.F. Mexico  
 T: +52.55.5573.5696 F: +52.55.5573.6976

**Ideal Tridon Clamps (Suzhou) Co., Ltd.**  
 Unit 16 Suchun Industrial Square  
 428 Xing Long Street, Suzhou Industrial Park  
 Suzhou, Jiangsu, PRC China, 215126  
 T: +86.512.8717.8660 F: +86.512.6283.8665

**Ideal-Tridon Clamp Products**  
**Sawakyu Industries Co Limited**  
 JR Central Towers 40fl. Suite 4008, 1-1-4 Meieki  
 Nakamura-ku, Nagoya, 450-6040, Japan  
 T: +81.52.581.3900 F: +81.52.581.3902

**Tridon Clamp Products Sp. z o. o.**  
 ul. Aleksandra Fredry 3  
 57-350 Kudowa Zdroj / Poland  
 T: +48.74.8135354 F: 48.74.8841017

**Ideal-Tridon Clamp (Mumbai) Co. Pvt. Ltd.**  
 A4, Ganesh Complex  
 Gundavali Village, Dapoda Road  
 Bhiwandi, India 421302  
 T: +91(0)77383330657

## Industry Markets

- General Aftermarket & Replacement
- OEM: Original Equipment Manufacturing
- Telecommunications
- Heavy Equipment
- Government & Military
- Food Processing & Sanitation
- Industrial
- Truck & Engine
- Automotive
- Marine
- Hardware
- Plumbing

## Global Presence

- Tennessee, USA Headquarters
- Texas, USA
- California, USA
- Matamoros, Mexico
- Mexico City, Mexico
- Suzhou, China
- Tokyo, Japan
- Kudowa Zdroj / Poland
- Mumbai, India



## IDEAL-TRIDON: The Fusion of Experience and Strength

When Ideal and Tridon merged over a decade ago, two extraordinary companies with complementary strengths joined to create one world class leader in the engineered joint sealing industry. A reputation for superior quality was built upon both IDEAL brand and TRIDON brand products. For over a decade both brands have been made in the same facilities to the same high quality standards demanded by OEM and aftermarket customers alike. The next step is the evolution of the two brands to one—the IDEAL-TRIDON brand. The IDEAL-TRIDON brand represents the legendary quality, reliability, and innovative engineering for which our products have always been known.

Although IDEAL-TRIDON is a forward-focused brand, we're also commemorating the rich and diverse history that led us to where we are today. The year 2016 marks a combined 196 years of experience in developing innovative joint-sealing solutions. Ideal was founded in 1913 by Philip Rauch, a taxi cab owner/operator with a background in automotive engineering. Tridon began in 1923 by Don Green, a young man trying to prove he could make it on his own. Throughout the last century literally billions of clamps have been made by the companies started by these two visionaries. The foundation for success built by both men sustains us to this day and will continue with our commitment to provide innovative clamping solutions backed by the best service in the industry.

Today we continue to build upon our founders' innovative spirit by constantly pushing boundaries with new IDEAL-TRIDON products. Our latest innovation is the SmartSeal® product line. This next generation clamp

uses patented technology to continuously seal in a steady 360 degree pattern while responding to pressure and temperature changes. We'd say that's pretty smart! Weighing less than traditional self-compensating clamps, SmartSeal is now being used on the newest fuel-efficient vehicles coming to market.

With the IDEAL-TRIDON brand, you're getting a product backed by 196 years of combined engineering excellence. Customers worldwide count on us to seal critical connections. Shouldn't you? After all, we've provided *"Proven Designs, Billions of Times."*

### **IDEAL-TRIDON Customers benefit from:**

- Quick quote turnaround\*
- 1-5 day lead time\*
- The widest selection of bands, screws, housings and special features
- Custom design and engineering expertise
- Metallurgical science specialists
- Automated assembly processes
- Advanced screw manufacturing technologies
- Sensors and visual control systems
- Attractive and marketable packaging
- Established distribution channels
- Quality testing and analysis
- Performance and specifications documentation

\*On standard products





**IDEAL-TRIDON's superior quality, environmental responsibility and process integrity has earned us certifications for TS16949 as well as ISO 9001 and 14001.** All our facilities worldwide use only the finest quality certified steel and the best practice manufacturing processes to craft clamp products you can trust today and years into the future.

We operate using the latest manufacturing equipment and facilities, from networked manufacturing complexes to advanced laboratory analysis. Our diversified team of engineers and operators are equipped with the most sophisticated testing labs and machine-tuning capabilities. We test and certify our clamp performance to stringent industry standards and real-life conditions to ensure your satisfaction.

### **Powerful Partnership**

Let us help you create a clamp offering for your distribution or supply your next order for a production line. We can connect you with our sales representatives and welcome you to partner with us as you plan your next clamp program.

### **IDEAL-TRIDON brand offers:**

- Unmatched customer service
- Mission critical engineering talent
- The world's broadest range of superior clamping products

### **Customization**

IDEAL-TRIDON is the industry leader in custom joint sealing products. We can develop custom designs for any application, from band notching and slotting to special finishes and screw head designs. Using 3-D modeling that includes stress and finite element analysis, we can help determine the best materials and configuration for your application.

### **Custom Options:**

- Special cut-out and detents added to bands
- Black e-coat or black oxide finishes
- Locating clips to pre-attach clamps to hoses
- Positioning clips to set the clamp distance from the end of a hose
- V-band clamps in custom configurations
- Materials specific for your operating environment
- And more!

Whether you need a standardized product or specialized attention, we have the team, the facilities and the knowledge to deliver a sealing solution.





**A**



**B**



**C**

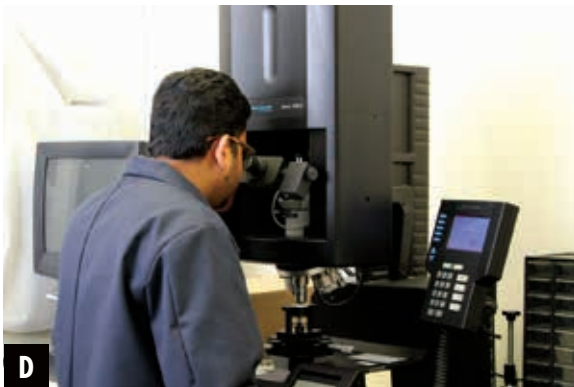

**D**



**E**



**F**

### Photo Captions

- A. VMM and CMM equipment provides precision measuring capability
- B. Full metallurgical laboratory capabilities for identification of alloys, material hardness and micro-structure
- C. On-site laboratory PVT chamber enables SAE J1610 pressure, vibration, and thermal testing
- D. Micro-hardness tester provides accurate and fast in-depth analysis of components and finished product specimens
- E. Accurate and controlled corrosion testing is possible using our salt-fog and cyclical corrosion test chambers
- F. The 8-segment load tester and DC servo installation tools allow for quick and accurate installation simulations

# HOW TO USE THIS CATALOG

## Part Number Explanation

IDEAL-TRIDON uses both **12-digit and 7-digit part numbers** with Tridon part numbers listed for reference only. Putting your part number together is an easy two-step process.

1. **Select the Ideal-Tridon part number by series and size** listed in the tables throughout the catalog.
2. **Add appropriate pack code to the end.**

Pack Type	7-Digit Pack Code Suffix	12-Digit Pack Code
<b>10-Pack</b> <i>(up to size 104)</i>	51	051
<b>Bulk</b>	52	052
<b>10-Pack Individually Barcoded</b> <i>(up to size 104)</i>	53	053
<b>Blister Pack</b>	58	058
* Not every product available in 10-Pack configuration, barcoded, or in blister pack		

Products are Color-Coded for Easy Identification

FIND YOUR PART NUMBER					Ideal-Tridon 67-4	Tridon 620P	Ideal-Tridon 67-5	Ideal-Tridon 67-1	Ideal-Tridon 57-0	Ideal-Tridon 52-0	Ideal-Tridon 67-6
Size	Min (in)	Max (in)	Min (mm)	Max (mm)							
6	3/8	7/8	10	22	67004-0006	620-P06	6706-5	6706-1	57060	52060	6706-6
8	7/16	1	11	25	67004-0008	620-P08	6708-5	6708-1	57080	52080	6708-6

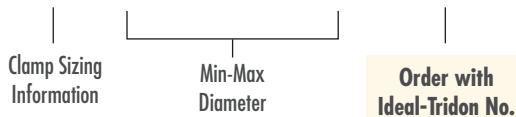

### EXAMPLE USING 12-DIGIT PART NUMBERS (Ordering a Size 06 1/2" Hy-Gear 67-4 in a 10-Pack)

Series (First 5 Digits)	+	Size (Next 4 Digits)	+	Pack Code (Last 3 Digits)	=	Complete Part Number
<b>67004</b> (Series 67-4)	+	<b>0006</b> (4-Digit Size)	+	<b>051</b> (3-Digit Pack Code)	=	<b>67004-0006-051</b>

### EXAMPLE USING 7-DIGIT PART NUMBERS (Ordering a Size 06 1/2" Hy-Gear 67-1 in 10-Pack)

Series & Size (First 5 Digits)	+	Pack Code (Last 2 Digits)	=	Complete Part Number
<b>6706-1</b> (Series 67-1 in Size 06)	+	<b>51</b> (10-Pack)	=	<b>6706-1-51</b>

## About Our Clamps (3 Piece Design)

### ONE-PIECE HOUSING

One piece mechanically interlocked housings are made from a single stamping with no tabs or stakes that can fail under higher tightening torques



### MULTIPLE BAND WIDTHS

Our three piece clamps are produced in a multitude of band widths in a large variety of sizes, traditionally sized in increments of 1/16"

### RECTANGULAR SHAPED NOTCHES

The rectangular notch design utilizes a radius at each corner which minimizes stress cracking under higher band loads and enhances the overall strength of the band













MORE CORROSION RESISTANCE

FIND YOUR MATERIAL

		Plated Carbon Steel	400 Stainless	200 Stainless	300 Stainless	316 Stainless
<b>Markets</b>	Automobile	•	•	•	•	•
	Farm	•		•	•	•
	Food				•	•
	Garden			•	•	•
	Heavy Duty		•		•	•
	Home	•	•	•	•	•
	Industrial/MRO	•		•	•	•
	Marine				•	•
	Medical					•
	Plumbing/Watersystems		•	•	•	•
	Turbo/Forced Air		•		•	•
<b>Characteristics</b>	Highest Corrosion Resistance					•
	Best Corrosion Resistance				•	
	Better Corrosion Resistance			•		
	Good Corrosion Resistance		•			
<b>Properties*</b>	Material is "Non-Magnetic"			•	•	•
	Material is "Magnetic"	•	•			
<b>Certifications</b>	IAPMO Listed Product Applications			•	•	

\*Materials may exhibit relatively small amounts of residual magnetism as a result of the manufacturing process

Icon Key

					
<b>BAND</b> Width & Material	<b>BOLT</b> Size & Material	<b>BRIDGE</b> Width & Material	<b>HOUSING</b> Size & Material	<b>LINER</b> Width & Material	<b>NUT</b> Size & Material
					
<b>SCREW</b> Size & Material	<b>SPRING</b> Size & Material	<b>SPRING LINER</b> Width & Material	<b>T-BOLT</b> Size & Material	<b>TRUNNION</b> Material	<b>RIT*</b> In-lbs & Nm





**\*RECOMMENDED INSTALLATION TORQUE**  
Overtightening your clamp can damage your hose and decrease clamping efficiency.



SmartSeal and WaveSeal<sup>360</sup> hybrid smart clamps secure hose connections and prevent unwanted flow of fluid and air. Through patented hybrid technology, these next generation clamps seal in a steady 360 degree pattern in response to pressure and temperature changes. With their compact design and lower profile, you get an optimal heavy-duty constant tension clamp without all the bulk.







### SmartSeal Ideal-Tridon 37215

5/16" Hex Head	Housing	1/2" Band	1/2" Spring Liner
			
300 Stainless	300 Stainless	300 Stainless	300 Stainless







### WaveSeal<sup>360</sup> Ideal-Tridon 36003

5/16" Hex Head	Housing	9/16" Band	9/16" Spring Liner
			
410 Stainless	300 Stainless	300 Stainless	300 Stainless



### SmartSeal HD Ideal-Tridon 38215

5/16" Hex Head	2-Piece Housing	5/8" Band	5/8" Spring Liner
			
410 Stainless	300 Stainless	300 Stainless	300 Stainless

#### THE SMARTSEAL CHANNEL DESIGN

High Pressure

- Spring compensation over 360 degrees
- Improved clamp roundness eliminates leak paths at housing juncture
- Trough-shaped design creates higher pressure loading compared to conventional worm gear, increasing resistance against potential leaks
- Trough shape helps clamp "grip" by penetrating deeper into the hose wall over a narrower cross-section (footprint)

#### THE WAVESEAL O-RING EFFECT

High Pressure Low Pressure High Pressure

- Spring compensation over 360 degrees
- Improved clamp roundness eliminates leak paths at housing juncture
- O-ring effect allows hose to act as an additional spring component
- Outside, chamfered liner edge protects hose component from cutting

### WHICH CLAMP IS RIGHT FOR ME?

General Guidelines	SmartSeal	WaveSeal <sup>360</sup>	SmartSeal HD
Wall Thickness	Greater than .177" (4.5 mm)	Less than .177" (4.5 mm)	.080 to .315" (2-8 mm)
Hose Diameter	Greater than 3" (76 mm)	Less than 3" (76 mm)	Greater than 2" (51 mm)
Installation Torque (Most Applications)	Up to 48 in-lbs (5.4 Nm)	Up to 70 in-lbs (7.9 Nm)	Up to 100 in-lbs (11.3 Nm)
Band Width	1/2"	9/16"	5/8"

### FIND YOUR PART NUMBER

Size	Min (in)	Max (in)	Min (mm)	Max (mm)	SmartSeal	WaveSeal <sup>360</sup>
16	1-3/32	1-9/32	28	33	37215-0016*	36003-0016
20	1-1/8	1-9/16	29	40	37215-0020*	36003-0020
22	1-7/16	1-11/16	36	43	37215-0022	36003-0022
24	1-1/2	1-13/16	38	46	37215-0024*	36003-0024
28	1-3/4	2-1/16	43	52	37215-0028*	36003-0028
32	1-15/16	2-5/16	48	59	37215-0032	36003-0032
34	2	2-7/16	50	62	37215-0034	36003-0034
36	2-1/8	2-9/16	53	65	37215-0036*	36003-0036
40	2-5/16	2-13/16	58	71	37215-0040*	36003-0040
44	2-1/2	3-1/16	63	78	37215-0044	36003-0044
48	2-11/16	3-5/16	67	84	37215-0048	36003-0048
52	2-7/8	3-9/16	73	91	37215-0052	36003-0052
56	3-1/16	3-13/16	77	97	37215-0056	36003-0056
60	3-1/4	4-1/16	82	103	37215-0060	36003-0060
64	3-7/16	4-5/16	87	110	37215-0064	36003-0064
72	3-3/4	4-13/16	96	122	37215-0072	36003-0072
80	4-3/16	5-5/16	105	135	37215-0080	36003-0080
88	4-1/2	5-13/16	115	148	37215-0088	36003-0088

SmartSeal 37215 series also available individually barcoded in 10-piece sub pack boxes

\*Available in blister pack

### FIND YOUR PART NUMBER



Size	Min (in)	Max (in)	Min (mm)	Max (mm)	SmartSeal HD
238	1-5/8	2-1/8	42	54	38215-0238
262	1-7/8	2-3/8	48	61	38215-0262
275	2	2-1/2	52	64	38215-0275
288	2-1/8	2-5/8	55	67	38215-0288
300	2-1/4	2-3/4	58	70	38215-0300
325	2-1/2	3	64	77	38215-0325
350	2-3/4	3-1/4	70	83	38215-0350
375	2-7/8	3-1/2	74	90	38215-0375
400	3-1/8	3-3/4	79	96	38215-0400
425	3-5/16	4	84	103	38215-0425
450	3-7/16	4-1/4	88	109	38215-0450
512	4-1/16	4-7/8	103	125	38215-0512
562	4-9/16	5-3/8	115	137	38215-0562
612	5-1/16	5-7/8	128	150	38215-0612

Micro-Gear clamps are tiny, tough and precision-engineered to use in small hose applications including emission control, fuel lines and vacuum hoses. Slim, 5/16" bands and low profile housings allow installation in confined areas.

**• BEST •**





**Micro-Gear Tridon 359**

1/4" Hex Head	Housing	5/16" Band Width
		
316 Stainless	316 Stainless	316 Stainless

**• BETTER •**





**Micro-Gear Ideal-Tridon 62M • Tridon 345/MAH**

1/4" Hex Head	Housing	5/16" Band Width
		
300 Stainless	300 Stainless	300 Stainless

**• GOOD •**





**Micro-Gear Ideal-Tridon 62P • Tridon 325/MH**

1/4" Hex Head	Housing	5/16" Band Width
		
Plated Carbon Steel	300 Stainless	300 Stainless

**• ECONOMY •**



**Micro-Gear Ideal-Tridon 52M**

1/4" Hex Head	Housing	5/16" Band Width
		
Plated Carbon Steel	Plated Carbon Steel	300 Stainless



10 to 15 in-lbs (1.1 to 1.7 Nm) for most applications



**FIND YOUR PART NUMBER**

Size	Min (in)	Max (in)	Min (mm)	Max (mm)	Tridon 359	Ideal-Tridon 62M	Ideal-Tridon 62P	Ideal-Tridon 52M
04	5/16	5/8	8	16	359-004	62604 <sup>(1)</sup>	6204 <sup>(3)</sup>	5202
05	5/16	3/4	8	19	-	62M05	62P05	-
06	5/16	7/8	8	22	359-006	62606 <sup>(2)</sup>	6206 <sup>(4)</sup>	5203
08	7/16	1	11	25	359-008	62M08	62P08	-
10	1/2	1-1/16	13	27	359-010	62M10	62P10	-
12	9/16	1-1/4	14	32	-	62M12	62P12	-
16	11/16	1-1/2	18	38	-	62M16	62P16	-
20	3/4	1-3/4	19	44	-	62M20	62P20	-
24	1	2	26	51	-	62M24	62P24	-
28	1-1/4	2-1/4	32	57	-	62M28	62P28	-
30	1-3/8	2-3/8	35	60	-	62M30	62P30	-
32	1-1/2	2-1/2	38	63	-	62M32	62P32	-
36	1-3/4	2-3/4	45	70	-	62M36	62P36	-
44	2-1/4	3-1/4	57	82	-	62M44	62P44	-
48	2-1/2	3-1/2	64	89	-	62M48	62P48	-

<sup>(1)</sup> Old part no. 62602 <sup>(2)</sup> Old part no. 62603 <sup>(3)</sup> Old part no. 6202 <sup>(4)</sup> Old part no. 6203

**Fuel Injection** clamps are designed to provide the uniform sealing pressure required on fuel injection hoses. They feature a solid band with rolled edges and a special nut and bolt design.

SPECIALTY



**Fuel Injection Ideal-Tridon 52F • Tridon 905/FI**

7 mm Hex Head  
  
 Plated Carbon Steel

9 mm Band Width  
  
 Plated Carbon Steel

**FIND YOUR PART NUMBER**

Size	Min (in)	Max (in)	Min (mm)	Max (mm)	Ideal-Tridon 52F	Tridon 905/FI
13	7/16	1/2	11	13	52F13	905-004
15	1/2	9/16	13	15	52F15	905-006
16	9/16	5/8	14	16	52F16	905-008

1/2" Hy-Gear clamps are suitable for most common household, industrial, and automotive applications. The bands have clean punched rectangular perforations that hold strong and connect easily.

Quality Level	Model	Hex Head	Housing	Band Width
• BEST •	1/2" Hy-Gear Ideal-Tridon 67-4 • Tridon 620P	5/16" Hex Head 300 Stainless	UPC Shield 300 Stainless	1/2" Band Width 300 Stainless
	1/2" Hy-Gear Ideal-Tridon 67-1	5/16" Hex Head 410 Stainless*	Housing 200 Stainless	1/2" Band Width 200 Stainless
	1/2" Hy-Gear Ideal-Tridon 67-5	5/16" Hex Head 200 Stainless	UPC Shield 200 Stainless	1/2" Band Width 200 Stainless
• GOOD •	1/2" Hy-Gear Ideal-Tridon 57-0	5/16" Hex Head Plated Carbon Steel	Housing 200 Stainless	1/2" Band Width 200 Stainless
	1/2" Hy-Gear Ideal-Tridon 52-0	5/16" Hex Head Plated Carbon Steel	Housing Plated Carbon Steel	1/2" Band Width 200 Stainless
• SPECIALTY •	1/2" Hy-Gear Ideal-Tridon 67-6	5/16" Hex Head 316 Stainless	Housing 316 Stainless	1/2" Band Width 316 Stainless

### FIND YOUR PART NUMBER

Size	Min (in)	Max (in)	Min (mm)	Max (mm)	Ideal-Tridon 67-4	Tridon 620P	Ideal-Tridon 67-1	Ideal-Tridon 67-5	Ideal-Tridon 57-0	Ideal-Tridon 52-0	Ideal-Tridon 67-6
6	3/8	7/8	10	22	67004-0006	620-P06	6706-1	6706-5	57060	52060	6706-6
8	7/16	1	11	25	67004-0008	620-P08	6708-1	6708-5	57080	52080	6708-6
10	1/2	1-1/16	13	27	67004-0010	620-P10	6710-1	6710-5	57100	52100	6710-6
12	1/2	1-1/4	13	32	67004-0012	620-P12	6712-1	6712-5	57120	52120	6712-6
16	11/16	1-1/2	18	38	67004-0016	620-P16	6716-1	6716-5	57160	52160	6716-6
20	3/4	1-3/4	19	44	67004-0020	620-P20	6720-1	6720-5	57200	52200	6720-6
24	1	2	25	51	67004-0024	620-P24	6724-1	6724-5	57240	52240	6724-6
28	1-1/4	2-1/4	32	57	67004-0028	620-P28	6728-1	6728-5	57280	52280	6728-6
32	1-1/2	2-1/2	38	63	67004-0032	620-P32	6732-1	6732-5	57320	52320	6732-6
36	3/4	2-3/4	19	70	67004-0036	620-P36	6736-1	6736-5	57360	52360	6736-6
40	1	3	26	76	67004-0040	620-P40	6740-1	6740-5	57400	52400	6740-6
44	1-1/4	3-1/4	32	82	67004-0044	620-P44	6744-1	6744-5	57440	52440	6744-6
48	1-1/2	3-1/2	38	89	67004-0048	620-P48	6748-1	6748-5	57480	52480	6748-6
52	1-3/4	3-3/4	44	95	67004-0052	620-P52	6752-1	6752-5	57520	52520	6752-6
56	2	4	51	101	67004-0056	620-P56	6756-1	6756-5	57560	52560	6756-6
60	2-1/4	4-1/4	57	108	67004-0060	620-P60	6760-1	6760-5	57600	52600	6760-6
64	2-1/2	4-1/2	64	114	67004-0064	620-P64	6764-1	6764-5	57640	52640	6764-6
72	3	5	76	127	67004-0072	620-P72	6772-1	6772-5	57720	52720	6772-6
80	3-1/2	5-1/2	89	140	67004-0080	620-P80	6780-1	6780-5	57800	52800	6780-6
88	4	6	102	152	67004-0088	620-P88	6788-1	6788-5	57880	52880	6788-6
96	4-1/2	6-1/2	114	165	67004-0096	620-P96	6796-1	6796-5	57960	52960	6796-6
104	5	7	127	178	67004-0104	62P-104	67104	6799-5	57104	52104	6799-6
112	5-1/2	7-1/2	140	190	67004-0112						
116	5-3/4	7-3/4	146	197	67004-0116						
120	6	8	152	203	67004-0120						
128	6-1/2	8-1/2	165	216	67004-0128						
132	6-3/4	8-3/4	171	222	67004-0132						
140	7-1/4	9-1/4	184	235	67004-0140						
152	2	10	51	254	67004-0152						
164	1-3/4	10-3/4	44	273	67004-0164						
176	9-1/2	11-1/2	241	292	67004-0176						
188	2	12-1/4	52	311	67004-0188						
208	11-1/4	13-1/2	294	343	67004-0208						
212	11-1/2	13-3/4	300	349	67004-0212						
224	12-1/2	14-1/2	319	368	67004-0224						
236	13-1/4	15-1/4	338	387	67004-0236						
248	1-3/4	16	44	406	67004-0248						
270	15-1/4	17-1/2	392	441	67004-0270						
312	18	20	459	508	67004-0312						
332	19-1/4	21-1/4	491	540	67004-0332						
390	14-1/2	25	371	636	67004-0390						
502	28	32	711	812	67004-0502						
538	24-3/4	34-1/4	628	869	67004-0538						
569	32	36-1/4	810	819	67004-0569						



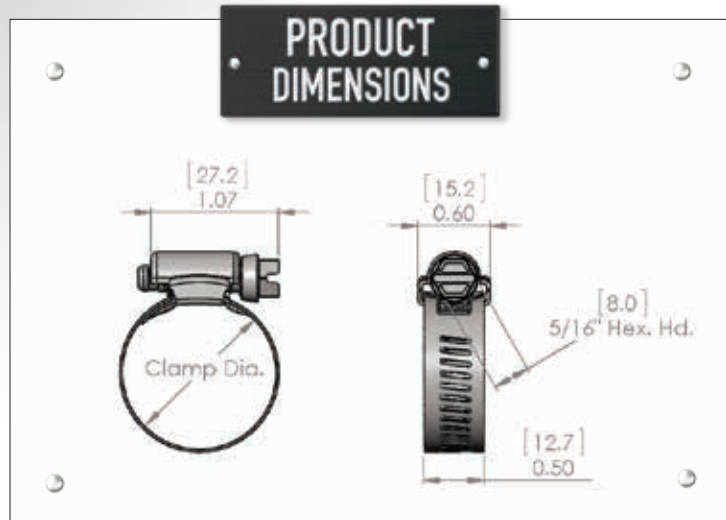













Additional sizes available



35 in-lbs (4 Nm) for most applications



9/16" Hy-Gear clamps have a wide range of applications, from simple home and auto repair to heavy industrial. The bands have clean punched rectangular perforations that hold strong and connect easily.

	<b>• BEST •</b>	<b>Hy-Gear Ideal-Tridon 63-4</b>		
	5/16" Hex Head	UPC Shield	9/16" Band Width	
				
	300 Stainless	300 Stainless	300 Stainless	
	<b>• BETTER •</b>	<b>Hy-Gear Ideal-Tridon 68-0</b>		
	5/16" Hex Head	Housing	9/16" Band Width	
				
	410 Stainless	200 Stainless	200 Stainless	
	<b>• GOOD •</b>	<b>Hy-Gear Ideal-Tridon 50-0</b>		
	5/16" Hex Head	Housing	9/16" Band Width	
				
	Plated Carbon Steel	200 Stainless	200 Stainless	
	<b>• SPECIALTY •</b>	<b>Hy-Gear Ideal-Tridon 64-0</b>		
	3/8" Hex Head	Housing	9/16" Band Width	
				
	410 Stainless	200 Stainless	200 Stainless	



35 in-lbs (4 Nm) for most applications

**FIND YOUR PART NUMBER**

Size	Min (in)	Max (in)	Min (mm)	Max (mm)	Ideal-Tridon 63-4	Ideal-Tridon 68-0	Ideal-Tridon 50-0	Ideal-Tridon 64-0
6	3/8	7/8	10	22	63004-0006	68060	50060	64060
8	7/16	1	11	25	63004-0008	68080	50080	64080
10	1/2	1-1/16	13	27	63004-0010	68100	50100	64100
12	1/2	1-1/4	13	32	63004-0012	68120	50120	64120
16	11/16	1-1/2	18	38	63004-0016	68160	50160	64160
20	3/4	1-3/4	19	44	63004-0020	68200	50200	64200
24	1	2	25	51	63004-0024	68240	50240	64240
28	1-1/4	2-1/4	32	57	63004-0028	68280	50280	64280
32	1-1/2	2-1/2	38	63	63004-0032	68320	50320	64320
36	3/4	2-3/4	19	70	63004-0036	68360	50360	64360
40	1	3	26	76	63004-0040	68400	50400	64400
44	1-1/4	3-1/4	32	83	63004-0044	68440	50440	64440
48	1-1/2	3-1/2	38	89	63004-0048	68480	50480	64480
52	1-3/4	3-3/4	44	95	63004-0052	68520	50520	64520
56	2	4	51	101	63004-0056	68560	50560	64560
60	2-1/4	4-1/4	57	108	63004-0060	68600	50600	64600
64	2-1/2	4-1/2	64	114	63004-0064	68640	50640	64640
72	3	5	76	127	63004-0072	68720	50720	64720
80	3-1/2	5-1/2	89	140	63004-0080	68800	50800	64800
88	4	6	102	152	63004-0088	68880	50880	64880
96	4-1/2	6-1/2	114	165	63004-0096	68960	50960	64960
104	5	7	127	178	63004-0104	68104	50104	64104
116	5-3/4	7-3/4	146	197	63004-0116			
128	2-1/2	8-1/2	64	216	63004-0128			
140	2-1/2	9-1/4	64	235	63004-0140			
152	2-1/2	10	64	254	63004-0152			
164	2-1/2	10-3/4	64	273	63004-0164			
176	2-1/2	11-1/2	64	292	63004-0176			
188	2-1/2	12-1/4	64	311	63004-0188			
208	2-1/2	13-1/2	64	343	63004-0208			
224	2-1/2	14-1/2	64	368	63004-0224			
236	2-1/2	15-1/4	64	387	63004-0236			
248	2-1/2	16	64	406	63004-0248			
260	2-1/2	16-3/4	64	425	63004-0260			
272	2-1/2	17-1/2	64	445	63004-0272			
312	2-1/2	20	64	508	63004-0312			
380	2-1/2	24-1/4	64	616	63004-0380			
760	2-1/2	48	64	1219	63004-0760			

Additional sizes available

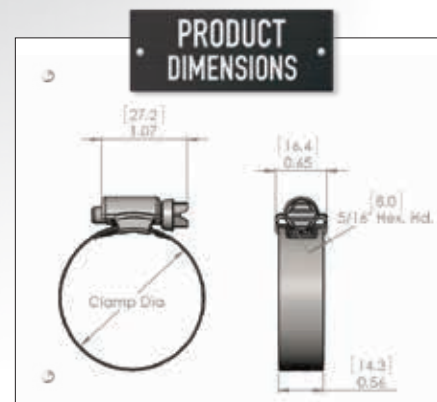

# NON-PERFORATED

**Non-Perforated (Embossed)** clamps are based on our popular general purpose worm gear clamps, but are engineered to prevent hose damage during installation. The non-perforated band keeps soft silicone hoses from shearing or extruding during installation and final torquing, maintaining the integrity of the connection, and providing a more stable seal. Plus, IDEAL-TRIDON Non-Perforated clamps are available in several material configurations making them perfect for automotive, marine and many industrial applications. Better yet, they act and perform just like traditional worm gear clamps, fitting into restricted spaces and holding tightly over time. Consider IDEAL-TRIDON Non-Perforated worm gear clamps for your next application, and get the assurance of damage-free clamping technology to keep your connection secure.

## WIDE CROSS SADDLE

Wide cross saddle provides a more even support structure upon installation and longer term band tension.



**MEETS OR EXCEEDS  
DIN 3017 STANDARD**

## MATERIAL SPECIFICATIONS AND CLAMPING RANGES

Material specifications and clamping ranges are stamped on clamp band for easy identification and proper application fitment. (See chart on right)

## SMOOTH INSIDE BAND

Smooth inside band protects soft hoses against shearing and fray, extending service life.



### 9 mm Band

7 mm Hex Head



Housing



9 mm Band Width



For material composition please see chart on right.



18 in-lbs (2.0 Nm) for sizes 016 and below  
27 in-lbs (3.0 Nm) for sizes 018 and up



### 12 mm Band

7 mm Hex Head



Housing



12 mm Band Width



For material composition please see chart on right.



44 in-lbs (5.0 Nm) for most applications



### FIND YOUR PART NUMBER

Band Width	Min (in)	Max (in)	Min (mm)	Max (mm)	W2 Ideal-Tridon	W2 Tridon	W3 Ideal-Tridon	W3 Tridon	W4 Ideal-Tridon	W4 Tridon	W5 Ideal-Tridon	W5 Tridon
9 mm	5/16	15/32	8	12	53302-0012	53312-0012	53303-0012	53313-0012	53304-0012	53314-0012	53305-0012	53315-0012
	5/16	5/8	8	16	53302-0016	53312-0016	53303-0016	53313-0016	53304-0016	53314-0016	53305-0016	53315-0016
	15/32	25/32	12	20	53302-0020	53312-0020	53303-0020	53313-0020	53304-0020	53314-0020	53305-0020	53315-0020
	15/32	7/8	12	22	53302-0022	53312-0022	53303-0022	53313-0022	53304-0022	53314-0022	53305-0022	53315-0022
	5/8	1-1/16	16	27	53302-0027	53312-0027	53303-0027	53313-0027	53304-0027	53314-0027	53305-0027	53315-0027
	25/32	1-1/4	20	32	53302-0032	53312-0032	53303-0032	53313-0032	53304-0032	53314-0032	53305-0032	53315-0032
	29/32	1-3/8	23	35	53302-0035	53312-0035	53303-0035	53313-0035	53304-0035	53314-0035	53305-0035	53315-0035
	1	1-9/16	25	40	53302-0040	53312-0040	53303-0040	53313-0040	53304-0040	53314-0040	53305-0040	53315-0040
	1-3/16	1-3/4	30	45	53302-0045	53312-0045	53303-0045	53313-0045	53304-0045	53314-0045	53305-0045	53315-0045
	1-1/4	1-31/32	32	50	53302-0050	53312-0050	53303-0050	53313-0050	53304-0050	53314-0050	53305-0050	53315-0050
	1-9/16	2-3/8	40	60	53302-0060	53312-0060	53303-0060	53313-0060	53304-0060	53314-0060	53305-0060	53315-0060
	1-31/32	2-3/4	50	70	53302-0070	53312-0070	53303-0070	53313-0070	53304-0070	53314-0070	53305-0070	53315-0070
	2-3/8	3-1/8	60	80	53302-0080	53312-0080	53303-0080	53313-0080	53304-0080	53314-0080	53305-0080	53315-0080
	2-3/4	3-1/2	70	90	53302-0090	53312-0090	53303-0090	53313-0090	53304-0090	53314-0090	53305-0090	53315-0090
	3-1/8	3-15/16	80	100	53302-0100	53312-0100	53303-0100	53313-0100	53304-0100	53314-0100	53305-0100	53315-0100
	3-1/2	4-5/16	90	110	53302-0110	53312-0110	53303-0110	53313-0110	53304-0110	53314-0110	53305-0110	53315-0110
	3-15/16	4-23/32	100	120	53302-0120	53312-0120	53303-0120	53313-0120	53304-0120	53314-0120	53305-0120	53315-0120
	4-5/16	5-1/8	110	130	53302-0130	53312-0130	53303-0130	53313-0130	53304-0130	53314-0130	53305-0130	53315-0130
	4-23/32	5-1/2	120	140	53302-0140	53312-0140	53303-0140	53313-0140	53304-0140	53314-0140	53305-0140	53315-0140
	5-1/8	5-29/32	130	150	53302-0150	53312-0150	53303-0150	53313-0150	53304-0150	53314-0150	53305-0150	53315-0150
	5-1/2	6-5/16	140	160	53302-0160	53312-0160	53303-0160	53313-0160	53304-0160	53314-0160	53305-0160	53315-0160
	5/8	1-1/16	16	27	53402-0027	53412-0027	53403-0027	53413-0027	53404-0027	53414-0027	53405-0027	53415-0027
	25/32	1-1/4	20	32	53402-0032	53412-0032	53403-0032	53413-0032	53404-0032	53414-0032	53405-0032	53415-0032
	1	1-9/16	25	40	53402-0040	53412-0040	53403-0040	53413-0040	53404-0040	53414-0040	53405-0040	53415-0040
1-3/16	1-3/4	30	45	53402-0045	53412-0045	53403-0045	53413-0045	53404-0045	53414-0045	53405-0045	53415-0045	
1-1/4	1-31/32	32	50	53402-0050	53412-0050	53403-0050	53413-0050	53404-0050	53414-0050	53405-0050	53415-0050	
1-9/16	2-3/8	40	60	53402-0060	53412-0060	53403-0060	53413-0060	53404-0060	53414-0060	53405-0060	53415-0060	
1-31/32	2-3/4	50	70	53402-0070	53412-0070	53403-0070	53413-0070	53404-0070	53414-0070	53405-0070	53415-0070	
2-3/16	2-15/16	55	75	53402-0075	53412-0075	53403-0075	53413-0075	53404-0075	53414-0075	53405-0075	53415-0075	
2-3/8	3-1/8	60	80	53402-0080	53412-0080	53403-0080	53413-0080	53404-0080	53414-0080	53405-0080	53415-0080	
2-3/4	3-1/2	70	90	53402-0090	53412-0090	53403-0090	53413-0090	53404-0090	53414-0090	53405-0090	53415-0090	
3-1/8	3-15/16	80	100	53402-0100	53412-0100	53403-0100	53413-0100	53404-0100	53414-0100	53405-0100	53415-0100	
3-1/2	4-5/16	90	110	53402-0110	53412-0110	53403-0110	53413-0110	53404-0110	53414-0110	53405-0110	53415-0110	
3-15/16	4-23/32	100	120	53402-0120	53412-0120	53403-0120	53413-0120	53404-0120	53414-0120	53405-0120	53415-0120	
4-5/16	5-1/8	110	130	53402-0130	53412-0130	53403-0130	53413-0130	53404-0130	53414-0130	53405-0130	53415-0130	
4-23/32	5-1/2	120	140	53402-0140	53412-0140	53403-0140	53413-0140	53404-0140	53414-0140	53405-0140	53415-0140	
5-1/8	5-29/32	130	150	53402-0150	53412-0150	53403-0150	53413-0150	53404-0150	53414-0150	53405-0150	53415-0150	
5-1/2	6-5/16	140	160	53402-0160	53412-0160	53403-0160	53413-0160	53404-0160	53414-0160	53405-0160	53415-0160	
5-29/32	6-11/16	150	170	53402-0170	53412-0170	53403-0170	53413-0170	53404-0170	53414-0170	53405-0170	53415-0170	
6-5/16	7-3/32	160	180	53402-0180	53412-0180	53403-0180	53413-0180	53404-0180	-	53405-0180	-	
6-11/16	7-15/32	170	190	-	53412-0190	-	53413-0190	-	-	53405-0190	-	
7-3/32	7-7/8	180	200	-	53412-0200	-	53413-0200	-	-	53405-0200	-	

### WHICH CLAMP IS RIGHT FOR ME?

	Corrosion Resistance	Material Composition	Common Uses
W2	Average Requirements	430 Band & Housing Plated Carbon Steel Screw	Automotive • Truck Replacements • Industrial Applications
W3	Medium Requirements	All 430 Stainless Steel	Automotive OE • Industrial Applications
W4	High Requirements Low Magnetic Permeability	All 304 Stainless Steel	Critical Connections in Cars such as Petrol Pipes • Close to Electronic Circuits Agricultural Machinery • Motorbikes • Signs • General Outdoors • Stainless Steel Chimneys
W5	Maximum Requirements Salt Water Resistant Low Magnetic Permeability	All 316 Stainless Steel	Close to Electronic Circuits • Shipbuilding • Defense Technology • Food Processing Sewage Treatment Facilities

# BAND & BUCKLE

The IDEAL-TRIDON® band and buckle clamping system offers maximum banding and clamping capacity. Select the banding width, length and packaging option that works best for your lightweight or heavy duty application. Perfect for sturdy, all-weather binding and clamping. Exceptional value - use only as much as you need.

## Stainless Steel Clamping System

- Durable band - **MADE IN USA**
- Bands and Buckles are constructed of **201 stainless steel**
- Easy to use band tensioning tool
- Easily forms to suit any diameter
- Applications include insulation banding, sign mounting and cable bundling



### PLASTIC TOTES 201 SS Bands

Width (in)	Width (mm)	Thickness (in)	Thickness (mm)	Length (ft)	Length (m)	Master Carton Qty	Part No.
1/2	12.7	0.030	0.76	100	30.5	2	60080-204B-193
5/8	16	0.030	0.76	100	30.5	2	60080-205G-193
3/4	19	0.030	0.76	100	30.5	2	60080-206R-193



### STANDARD 201 SS Bands

Width (in)	Width (mm)	Thickness (in)	Thickness (mm)	Length (ft)	Length (m)	Master Carton Qty	Part No.
1/4	6.4	0.020	0.51	100	30.5	6	60080-0202-194
3/8	9.5	0.025	0.64	100	30.5	6	60080-0203-194
1/2	12.7	0.030	0.76	100	30.5	4	60080-0204-194
5/8	16	0.030	0.76	100	30.5	4	60080-0205-194
3/4	19	0.030	0.76	100	30.5	4	60080-0206-194
1/2	12.7	0.030	0.76	50	15	4	60080-5004-950
5/8	16	0.030	0.76	50	15	4	60080-5005-950
3/4	19	0.030	0.76	50	15	4	60080-5006-950



### ECONOMY 201 SS Bands

Width (in)	Width (mm)	Thickness (in)	Thickness (mm)	Length (ft)	Length (m)	Master Carton Qty	Part No.
1/2	12.7	0.020	0.51	100	30.5	4	60080-0181-200
3/4	19	0.020	0.51	100	30.5	4	60080-0161-200
1/2	12.7	0.020	0.51	200	61	2	60080-0183-200
3/4	19	0.020	0.51	200	61	2	60080-0163-200



EAR STYLE Buckles			
Width (in)	Width (mm)	Master Carton Qty*	Part No.
1/4	6.4	100	60081-0252-194
3/8	9.5	100	60081-0253-194
1/2	12.7	100	60081-0254-194
5/8	16	100	60081-0255-194
3/4	19	100	60081-0256-194

\*Must order in master carton quantities

WING STYLE Clips / Buckles			
Width (in)	Width (mm)	Master Carton Qty*	Part No.
1/2	12.7	100	60081-0154-295
3/4	19	100	60081-0156-295

\*Must order in master carton quantities

BAND TENSIONING TOOL	
Master Carton Qty	Part No.
1	60082-0001-194

### Single-Ear Pinch / Crimp Clamps and Tool

**Pinch clamps** are designed to fit most popular polyethylene and polybutylene water service lines, and are perfect for sprinkler systems, irrigation systems and most other low-pressure applications.



- Marine Grade Clamps
- All 300 stainless steel for excellent corrosion resistance
- Welded construction for superior strength
- Easy installation
- Permanent, tamper-proof 360° seal
- Compatible with most clinching tools

FIND YOUR PART NUMBER						
Nominal Dia. (in)	Min (in)	Max (in)	Min (mm)	Max (mm)	Qty Per Bag	Ideal-Tridon 61 Series
3/4	0.669	0.779	17	20	100	611985B
13/16	0.716	0.827	18	21	100	612105B
1	0.898	1.008	23	25	100	612565B
1-1/16	0.945	1.067	24	27	100	612715B
1-1/4	1.122	1.244	29	31	100	613165B
1-5/16	1.181	1.303	30	33	100	613315B
1-3/8	1.240	1.362	32	34	100	613465B
1-5/8	1.492	1.614	38	41	100	614105B
1-11/16	1.551	1.673	40	42	100	614255B
1-7/8	1.787	1.909	46	48	100	614855B

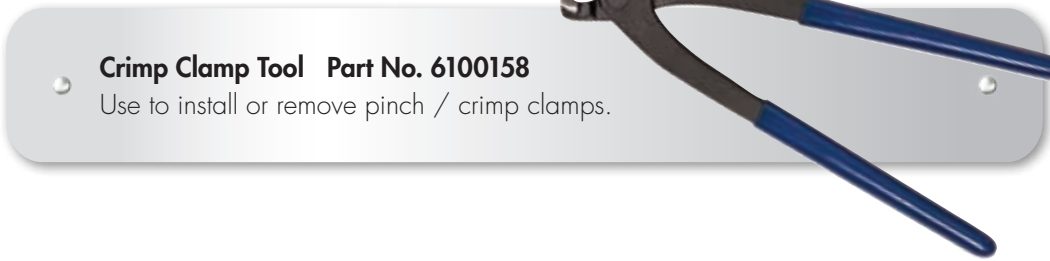

**Crimp Clamp Tool Part No. 6100158**  
Use to install or remove pinch / crimp clamps.



# COMBO HEX® & MILITARY WORM DRIVE

**Combo-Hex** clamps are the clamps professional mechanics choose most often. Particularly helpful in hard-to-reach areas, they feature an exclusive, safety-collared, deep-slotted screw design that prevents screwdrivers from slipping and puncturing the hose wall. Combo-Hex clamps can be installed with a screwdriver, nutdriver or socket wrench.



**Combo Hex Ideal-Tridon 54-0**

3/8" Safety-Collared Hex • Deep-Slotted      Housing      9/16" Band Width

Plated Carbon Steel      200 Stainless      200 Stainless



 35 in-lbs (4 Nm) for most applications

**Military Worm Drive** clamps are manufactured to military specification MS-35842 and AA-52506C.



**Military Worm Drive Ideal-Tridon 632 • Tridon 632**

5/16" Hex Head      Housing      1/2" Band Width

410 Stainless      201 Stainless      201 Stainless

 35 in-lbs (4 Nm) for most applications

## FIND YOUR PART NUMBER

Size	Min (in)	Max (in)	Min (mm)	Max (mm)	Ideal-Tridon 54-0	Ideal-Tridon 632 Tridon 632
6	3/8	7/8	10	22	54060	632-006
8	7/16	1	11	25	54080	-
10	1/2	1-1/16	13	27	54100	-
12	1/2	1-1/4	13	32	54120	632-012
16	11/16	1-1/2	18	38	54160	-
20	3/4	1-3/4	19	44	54200	-
24	1	2	25	51	54240	632-024
28	1-1/4	2-1/4	32	57	54280	-
32	1-1/2	2-1/2	38	63	54320	-
36	3/4	2-3/4	19	70	54360	632-036
40	1	3	26	76	54400	-
44	1-1/4	3-1/4	32	83	54440	-
48	2-1/2	3-1/2	64	89	54480*	632-048
52	1-3/4	3-3/4	44	95	54520	-
56	2	4	51	101	54560	-
60	3-5/16	4-1/4	84	108	-	632-060
104	4	7	102	178	-	632-104**

\*Min for 54480 is 1-1/2" 38 mm

\*\*Non-stocking item

# SURELOCK QUICK ENGAGE

**Surelock Quick Engage** worm drive clamps have a bind-free, pull-through design for fast installation. Captured screw design for quick fastening and trouble-free tensioning. Extended housing engages 25% more screw threads than competitive designs.



## Surelock Ideal-Tridon 48

5/16" Hex Head



305 Stainless

Two-Piece



304 Stainless

9/16" Band Width



304 Stainless



## Surelock Ideal-Tridon 49

5/16" Hex Head



316 Stainless

Two-Piece



316 Stainless

9/16" Band Width



316 Stainless



40 in-lbs (4.5 Nm) for most applications

### FIND YOUR PART NUMBER

Size	Min (in)	Max (in)	Min (mm)	Max (mm)	Ideal-Tridon 48	Ideal-Tridon 49
12	1/2	1-1/4	13	32	48012	-
20	3/4	1-3/4	19	44	48020	-
24	3/4	2	19	51	48024	-
28	1	2-1/4	25	57	48028	-
32	1-1/4	2-1/2	32	64	48032	49032
36	7/8	2-3/4	22	70	48036	-
48	1	3-1/2	25	89	48048	-
56	1	4	25	102	48056	-
72	2	5	51	127	48072	49073
80	1-13/16	5-1/2	48	140	48080	49080
88	2	6	51	152	48088	-
104	2	7	51	178	48104	49104
116	1-3/4	7-3/4	44	196	48116	-
128	4-1/4	8-1/2	108	216	48128	49128
152	4	10	102	254	48152	-
180	7-3/4	11-3/4	197	298	48180	49180
188	6-1/4	12-1/4	159	311	48188	-
190	6-3/8	12-3/8	162	314	48190	49190
218	11-3/16	14-5/16	284	359	48218	49218
224	8-1/2	14-1/2	216	368	48224	-
232	9	15	229	381	48232	-
242	12-11/16	15-5/8	323	397	48242	49242
248	2-1/2	16	63	406	48248	-
258	13-11/16	16-5/8	348	422	48258	49258
272	11-1/2	17-1/2	292	445	48272	-
282	15-3/16	18-1/8	386	460	48282	49282
288	12-1/2	18-1/2	318	470	48288	-
306	14-1/16	19-5/8	357	498	48306	49306
312	2-3/8	20	60	508	48312	-

Surelock 48: Sizes available up to size 598. Sizes 80 and above are shipped flat and disengaged • Surelock 49: All sizes are shipped flat and disengaged.



# SNAPLOCK® QUICK RELEASE

**Snaplock Quick Release** worm drive clamps are good for closed system applications where the clamp must be disengaged to be applied. The swivel-action locking of screw to band makes installation and removal much faster. All Snaplock housings are 200 stainless steel.

## Snaplock Ideal-Tridon 56-0



5/16" Hex Head



Plated Carbon Steel

Bridge



Plated Carbon Steel

9/16" Band Width



200 Stainless

## Snaplock Ideal-Tridon 500 • Tridon 500/LS

5/16" Hex Head



Plated Carbon Steel

Bridge



410 Stainless

1/2" Band Width



200 Stainless

## Snaplock Ideal-Tridon 58-0



3/8" Hex Head



410 Stainless

Bridge



410 Stainless

9/16" Band Width



200 Stainless

## Snaplock Ideal-Tridon 550 • Tridon 550/LAS

5/16" Hex Head



410 Stainless

Bridge



410 Stainless

1/2" Band Width



200 Stainless



30 in-lbs (3.4 Nm) for most applications

## FIND YOUR PART NUMBER

Size	Min (in)	Max (in)	Min (mm)	Max (mm)	Ideal-Tridon 56-0	Ideal-Tridon 500 Tridon 500/LS	Ideal-Tridon 58-0	Ideal-Tridon 550 Tridon 550/LAS
12	1/2	1-1/4	13	32	56120	500-012	5812	-
20	3/4	1-3/4	19	44	56200	500-020	5820	550-020
24	1-1/16	2	27	51	56240	-	5824	-
28	1	2-1/4	25	57	56280	-	5828	550-028
36	1	2-3/4	25	70	56360	500-036	5836	550-036
48	1-1/2	3-1/2	39	89	56480	500-048	5848	550-048
56	1	4	25	102	56560	500-056	5856	550-056
72	2	5	51	127	56720	500-072	5872	550-072
88	2	6	51	152	56880	500-088	5888	550-088
96	3-1/2	6-1/2	89	167	-	500-096	-	550-096
104	2-7/8	7	73	178	56104	500-104	58104	550-104
116	1-3/4	7-3/4	45	197	56116	500-116	58116	550-116
128	1-3/4	8-1/2	45	216	56128	500-128	58128	550-128
136	1-3/4	9	45	228	56136	-	-	550-136
152	2	10	51	254	56152	500-152	58152	550-152
188	2	12-1/4	51	311	56188	500-188	58188	550-188
216	10-3/16	14	259	356	-	500-216	-	550-216
224	2-1/2	14-1/4	64	362	-	-	58224	550-224
232	13-1/8	15	333	381	56232	500-232	-	-
248	1-3/4	16	44	406	-	500-248	-	550-248
258	1-15/16	16-5/8	50	422	56258	500-258	-	-
272	2	17	52	432	56272	-	-	-
280	14-1/4	18	362	457	-	500-280	-	550-280
288	1-13/16	18-1/2	45	470	56288	-	-	-
294	1-7/8	18-3/4	48	479	-	500-294	-	-
312	1-7/8	20	48	508	-	500-312	-	550-312
332	2	21-1/4	51	540	56332	-	58332	-
344	1-3/4	22	44	559	-	500-344	-	550-344
390	18-5/8	25	473	635	-	-	-	550-390

## No-Hub Couplings

**Ideal Clamp Products, Inc.** manufactures no-hub couplings that are listed or certified by all major plumbing code bodies throughout U.S. and Canada. Visit [www.idealtridon.com](http://www.idealtridon.com) for more information.





- Classic
- Standard
- Heavy Duty MD
- Heavy Duty HD
- 12" and 15"

Wraplock clamps, with their unique plated carbon steel buckles, conform to many shapes and are suitable for specialized applications.



## Wraplock Ideal-Tridon 59-0

5/16" Hex Head  
  
 Plated Carbon Steel

1/2" Band Width  
  
 Galvanized Steel

### FIND YOUR PART NUMBER

Size	Min (in)	Max (in)	Min (mm)	Max (mm)	Band Length (in)	Band Length (mm)	Ideal-Tridon 59-0
12	1	3-1/2	25	89	12	305	5912
15	1	4-1/2	25	114	15	381	5915
18	1	5	25	127	18	457	5918
24	1	7	25	178	24	610	5924
30	1	9	25	229	30	762	5930
48	1	14-1/2	25	368	48	1219	5948

Product ships flat, shown engaged for illustration purposes only

Lox-On clamps are for extra-tough installations. The unique design provides double-locking security with a 301 stainless steel buckle and high band tension for high sealing pressures.



## Lox-On Ideal-Tridon 69-0

5/16" Hex Head  
  
 305 Stainless

Housing  
  
 300 Stainless

1/2" Band Width  
  
 300 Stainless • UPC Shield

### FIND YOUR PART NUMBER

Size	Min (in)	Max (in)	Min (mm)	Max (mm)	Band Length (in)	Band Length (mm)	Ideal-Tridon 69-0
12	11/16	1-1/4	17	32	4-13/16	122	69120
20	11/16	1-3/4	17	44	6-13/32	163	69200
32	11/16	2-5/8	17	67	8-29/32	226	69320
72	1-3/4	5	44	127	16-5/16	414	69720
104	4	7-1/4	102	184	23-5/16	592	69104



Product ships flat, shown engaged for illustration purposes only

# TURN-KEY® & FLEXIBLE HOSE CLAMP DRIVER

**Turn-Key** clamps offer innovative design and install with a simple hand twist. No tools are required. Remove the reusable plastic screw cap for a tamper-resistant connection. Also available in blister pack assortment options. Applications include dryer vent hose, filter bags, RV sewer hose, cable and wire bundling.



Turn-Key Ideal-Tridon 5Y/6Y\*

 <b>Capped Screw</b> Plated Carbon Steel	 <b>Housing</b> 300 Stainless	 <b>1/2" Band Width</b> 200 Stainless
---	---	--

\*5/16" Band Width for 6Y



FIND YOUR PART NUMBER						
Size	Min (in)	Max (in)	Min (mm)	Max (mm)	Ideal-Tridon 5Y/6Y	Ideal-Tridon Blister Packs
4	5/16	5/8	8	16	6Y004	‡
6	3/8	7/8	10	22	6Y006	‡
12	1/2	1-1/4	13	32	5Y012	5Y01258*
20	3/4	1-3/4	19	44	5Y020	5Y02058*
28	1-1/4	2-1/4	32	57	5Y028	5Y02858*
36	1-3/4	2-3/4	44	70	5Y036	5Y03658*
48	2-1/2	3-1/2	64	89	5Y048	5Y04858*
64	2-1/2	4-1/2	64	114	5Y064	5Y06458*
‡Micro Assortment: Two each of size 4 and size 6						6Y00458
Six-Pack Assortment: One each of size 4, 6, 12, 20, 28, 36						5Y00158

\*Comes with 2 clamps per blister pack

**Flexible Hose Clamp Driver** Stop using that old, rigid nut driver and add some flexibility to your work! The flexible shaft and slipless grip provide 90-degree work access and are best in tight spaces such as compact car and boat engines, as well as plumbing repair applications. The socket fits mini and standard hose clamp screw heads. Just flip the socket for the desired size of 1/4" or 5/16" hex. Part No. **9999V\***

Flexible Hose Clamp Driver Part No. 9999V



 <b>1/4" Hex Head</b>	— or —	 <b>5/16" Hex Head</b>
--	--------	--

\*9999V shown on packaging. Complete part no. is 800019999058

**Lined** clamps are designed for use with silicone rubber and other soft hose applications. The liner protects the hose surface and prevents it from extruding or shearing through the band notches as the clamp is tightened.

## Lined Ideal-Tridon 65E



5/16" Hex Slotted



300 Stainless

Housing



300 Stainless

9/16" Lined Band



300 Stainless

## Lined Ideal-Tridon 615

5/16" Hex Slotted



300 Stainless

Housing



200 Stainless

1/2" Lined Band



200 Stainless

## Lined Ideal-Tridon 53-0 • Tridon 613/ET



5/16" Hex Slotted



Plated Carbon Steel

Housing



200 Stainless

1/2" Lined Band



200 Stainless

## Lined Ideal-Tridon 67M



5/16" Hex Slotted



316 Stainless

Housing



316 Stainless

1/2" Lined Band



316 Stainless



35 in-lbs (4 Nm) for most applications



### FIND YOUR PART NUMBER

Size	Min (in)	Max (in)	Min (mm)	Max (mm)	Ideal-Tridon 65E	Ideal-Tridon 615	Ideal-Tridon 53-0	Tridon 613/ET	Ideal-Tridon 67M
6	1/2	7/8	13	22	6506E	615-006	53060	613-006	N/A
8	5/8	1	16	25	6508E	615-008	53080	613-008	6708M
10	11/16	1-1/16	17	27	6510E	615-010	53100	613-010	6710M
12	11/16	1-1/4	17	32	6512E	615-012	53120	613-012	6712M
16	3/4	1-1/2	19	38	6516E	615-016	53160	613-016	6716M
20	1	1-3/4	25	44	6520E	615-020	53200	613-020	6720M
24	1-1/16	2	27	51	6524E	615-024	53240	613-024	6724M
28	1-5/16	2-1/4	33	57	6528E	615-028	53280	613-028	6728M
32	1-9/16	2-1/2	40	63	6532E	615-032	53320	613-032	6732M
36	1-13/16	2-3/4	46	70	6536E	615-036	53360	613-036	6736M
40	2-1/16	3	52	76	6540E	615-040	53400	613-040	6740M
44	2-5/16	3-1/4	59	82	6544E	615-044	53440	613-044	6744M
48	2-9/16	3-1/2	65	89	6548E	615-048	53480	613-048	6748M
52	2-13/16	3-3/4	72	95	6552E	615-052	53520	613-052	6752M
56	3-1/16	4	78	101	6556E	615-056	53560	613-056	6756M
60	3-5/16	4-1/4	84	108	6560E	615-060	53600	613-060	6760M
64	3-9/16	4-1/2	91	114	6564E	615-064	53640	613-064	6764M
72	4-1/16	5	103	127	6572E	615-072	53720	613-072	6772M
80	4-9/16	5-1/2	116	140	-	615-080	-	-	-
88	5-1/16	6	129	152	-	-	-	-	6788M
96	5-9/16	6-1/2	141	165	-	-	-	-	6796M

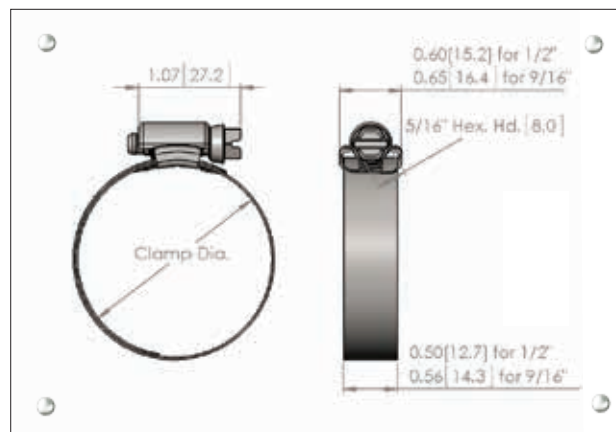

**Pow'r-Gear** high performance clamps are designed for high vibration and stubborn leakage applications such as industrial machinery, heavy truck, farm and off-road equipment engines. Pow'r-Gears feature an extra wide 5/8" heavy gauge band and a wide profile housing that provides maximum engagement of screw threads to band. Engineered to deliver exceptionally high rates of band tension to handle the toughest sealing jobs.

## Pow'r-Gear Ideal-Tridon 60 • Tridon M850



5/16" Hex Head



410 Stainless

Housing



300 Stainless

5/8" Band Width



300 Stainless

## Pow'r-Gear Ideal-Tridon 6P

5/16" Hex Head



305 Stainless

Housing



300 Stainless

5/8" Band Width



300 Stainless

## Pow'r-Gear Ideal-Tridon 6L • Tridon M843



5/16" Hex Head



410 Stainless

Housing



300 Stainless

5/8" Lined Band



300 Stainless

## Pow'r-Gear Ideal-Tridon 6M

5/16" Hex Head



305 Stainless

Housing



300 Stainless

5/8" Lined Band



300 Stainless



## Pow'r-Gear Ideal-Tridon 6X

5/16" Hex Head



410 Stainless

Housing



300 Stainless

5/8" Band Width



300 Stainless



75-90 in-lbs (8.5-10 Nm) for most applications

**FIND YOUR PART NUMBER**

Size	Min (in)	Max (in)	Min (mm)	Max (mm)	Ideal-Tridon 60	Tridon M850	Ideal-Tridon 6P	Ideal-Tridon 6L	Tridon M843	Ideal-Tridon 6M
175	1	1-3/4	25	45	60175	850-175	6P175	6L175	843-175	6M175
212	1-1/4	2-1/8	32	54	60200	850-200	6P200	6L200	843-200	6M200
262	1-3/4	2-5/8	45	66	60250	850-250	6P250	6L250	843-250	6M250
312	2-1/4	3-1/8	57	79	60300	850-300	6P300	6L300	843-300	6M300
362	2-3/4	3-5/8	70	92	60350	850-350	6P350	6L350	843-350	6M350
412	3-1/4	4-1/8	83	105	60400	850-400	6P400	6L400	843-400	6M400
462	3-3/4	4-5/8	95	117	60450	850-450	6P450	6L450	843-450	6M450
512	4-1/4	5-1/8	108	130	60500	850-500	6P500	6L500	843-500	6M500
562	4-3/4	5-5/8	121	143	60550	850-550	6P550	6L550	843-550	6M550
612	5-1/4	6-1/8	133	155	60600	850-600	6P600	6L600	843-600	6M600
662	5-3/4	6-5/8	146	168	60650	850-650	6P650	6L650	843-650	6M650
712	6-1/4	7-1/8	159	181	60700	850-700	6P700	6L700	843-700	6M700
762	6-3/4	7-5/8	172	193	60750	850-750	6P750	6L750	843-750	6M750
812	7-1/4	8-1/8	184	206	60800	850-800	6P800	6L800	843-800	6M800
862	7-3/4	8-5/8	197	219	60850	850-850	6P850	6L850	843-850	6M850
912	8-1/4	9-1/8	210	232	60900	850-900	6P900	6L900	843-900	6M900

## Did you know...

Pow'r-Gear 6X Series clamps have extra band notches for greater work range so five sizes cover clamping diameters from 1-1/4" to 10-1/8". This minimizes your inventory without compromising applications coverage. Plus, Pow'r-Gear clamps deliver over 800 lbs. of band tension at 150 in.-lbs. of torque. That's over twice the holding power of conventional clamps!

























**FIND YOUR PART NUMBER**

Size	Min (in)	Max (in)	Min (mm)	Max (mm)	Ideal-Tridon 6X
262	1-1/4	2-5/8	32	66	6X200
412	2	4-1/8	51	105	6X300
612	4	6-1/8	102	155	6X400
912	6	9-1/8	153	231	6X500
1012	7	10-1/8	178	257	6X600

Additional sizes available

# T-BOLTS - MINIMAL DIAMETERS

**T-Bolt** clamps provide uniform sealing pressure for a positive, reliable seal. Designed for use in high vibration and large diameter applications common in heavy trucks, industrial machinery, off-road equipment, agricultural irrigation and machinery. Features a 3/4" or 7/8" wide stainless steel band, depending upon size ordered, and welded construction for reliability.

Standard T-Bolt Ideal-Tridon 30010					
	1/4" T-Bolt	7/16" Hex Nut	3/4" Band	3/4" Bridge	Trunnion
	 Plated Carbon Steel	 Plated Carbon Steel Nylon Insert	 300 Stainless	 300 Stainless	 Plated Carbon Steel
Standard T-Bolt Ideal-Tridon 30011					
	1/4" T-Bolt	7/16" Hex Nut	3/4" Band	3/4" Bridge	Trunnion
	 300 Stainless	 300 Stainless Nylon Insert	 300 Stainless	 300 Stainless	 300 Stainless
Channel Bridge T-Bolt Ideal-Tridon 30020					
	1/4" T-Bolt	7/16" Hex Nut	3/4" Band	3/4" Bridge	Trunnion
	 Plated Carbon Steel	 Plated Carbon Steel Nylon Insert	 300 Stainless	 300 Stainless	 Plated Carbon Steel
Channel Bridge T-Bolt Ideal-Tridon 30021					
	1/4" T-Bolt	7/16" Hex Nut	3/4" Band	3/4" Bridge	Trunnion
	 300 Stainless	 300 Stainless Nylon Insert	 300 Stainless	 300 Stainless	 300 Stainless

Note: 7/8" wide bands and custom options by request



75 in-lbs (8.5 Nm) for most applications

**FIND YOUR PART NUMBER**

Size	Min (in)	Max (in)	Min (mm)	Max (mm)	Standard T-Bolt		Channel Bridge	
					Ideal-Tridon 30010*	Ideal-Tridon 30011*	Ideal-Tridon 30020	Ideal-Tridon 30021
138	1.38	1.57	35.1	39.9	30010-0138	30011-0138	30020-0138	30021-0138
150	1.50	1.69	38.1	42.9	30010-0150	30011-0150	30020-0150	30021-0150
163	1.63	1.88	41.3	47.8	30010-0163	30011-0163	30020-0163	30021-0163
175	1.75	2.00	44.5	50.8	30010-0175	30011-0175	30020-0175	30021-0175
188	1.88	2.19	47.6	55.6	30010-0188	30011-0188	30020-0188	30021-0188
200	2.00	2.31	50.8	58.7	30010-0200	30011-0200	30020-0200	30021-0200
213	2.13	2.44	54.1	62.0	30010-0213	30011-0213	30020-0213	30021-0213
225	2.25	2.56	57.2	65.0	30010-0225	30011-0225	30020-0225	30021-0225
238	2.38	2.69	60.3	68.3	30010-0238	30011-0238	30020-0238	30021-0238
250	2.50	2.81	63.5	71.4	30010-0250	30011-0250	30020-0250	30021-0250
263	2.63	2.94	66.7	74.7	30010-0263	30011-0263	30020-0263	30021-0263
275	2.75	3.06	69.9	77.7	30010-0275	30011-0275	30020-0275	30021-0275
288	2.88	3.19	73.0	81.0	30010-0288	30011-0288	30020-0288	30021-0288
300	3.00	3.31	76.2	84.1	30010-0300	30011-0300	30020-0300	30021-0300
313	3.13	3.44	79.4	87.4	30010-0313	30011-0313	30020-0313	30021-0313
325	3.25	3.56	82.6	90.4	30010-0325	30011-0325	30020-0325	30021-0325
338	3.38	3.69	85.7	93.7	30010-0338	30011-0338	30020-0338	30021-0338
350	3.50	3.81	88.9	96.8	30010-0350	30011-0350	30020-0350	30021-0350
363	3.63	3.94	92.1	100.1	30010-0363	30011-0363	30020-0363	30021-0363
375	3.75	4.06	95.3	103.1	30010-0375	30011-0375	30020-0375	30021-0375
400	4.00	4.31	101.6	109.5	30010-0400	30011-0400	30020-0400	30021-0400
425	4.25	4.56	108.0	115.8	30010-0425	30011-0425	30020-0425	30021-0425
450	4.50	4.81	114.3	122.2	30010-0450	30011-0450	30020-0450	30021-0450
475	4.75	5.06	120.7	128.5	30010-0475	30011-0475	30020-0475	30021-0475
500	5.00	5.31	127.0	134.9	30010-0500	30011-0500	30020-0500	30021-0500
525	5.25	5.56	133.4	141.2	30010-0525	30011-0525	30020-0525	30021-0525
550	5.50	5.81	139.7	147.6	30010-0550	30011-0550	30020-0550	30021-0550
575	5.75	6.06	146.1	153.9	30010-0575	30011-0575	30020-0575	30021-0575
600	6.00	6.31	152.4	160.3	30010-0600	30011-0600	30020-0600	30021-0600
625	6.25	6.56	158.8	166.6	30010-0625	30011-0625	30020-0625	30021-0625
650	6.50	6.81	165.1	173.0	30010-0650	30011-0650	30020-0650	30021-0650
675	6.75	7.06	171.5	179.3	30010-0675	30011-0675	30020-0675	30021-0675
700	7.00	7.31	177.8	185.7	30010-0700	30011-0700	30020-0700	30021-0700
725	7.25	7.56	184.2	192.0	30010-0725	30011-0725	30020-0725	30021-0725
750	7.50	7.81	190.5	198.4	30010-0750	30011-0750	30020-0750	30021-0750
775	7.75	8.06	196.9	204.7	30010-0775	30011-0775	30020-0775	30021-0775
800	8.00	8.31	203.2	211.1	30010-0800	30011-0800	30020-0800	30021-0800
825	8.25	8.56	209.6	217.4	30010-0825	30011-0825	30020-0825	30021-0825
850	8.50	8.81	215.9	223.8	30010-0850	30011-0850	30020-0850	30021-0850

Additional sizes available  
 \*Available individually barcoded



# T-BOLTS - NOMINAL DIAMETERS

**Nominal Diameter Sized T-bolt** clamps provide uniform sealing pressure for a positive, reliable seal. Designed for use in high vibration and large diameter applications common in heavy trucks, industrial machinery, off-road equipment, agricultural irrigation and machinery. Easy to interchange competitors part numbers.

**30050**



**1/4" T-Bolt**  
  
 Plated Carbon Steel

**7/16" Hex Nut**  
  
 Plated Carbon Steel  
 Nylon Insert

**3/4" Band**  
  
 300 Stainless

**3/4" Bridge**  
  
 300 Stainless

**Trunnion**  
  
 Plated Carbon Steel

**Standard T-Bolt**

**30051**



**1/4" T-Bolt**  
  
 300 Stainless

**7/16" Hex Nut**  
  
 300 Stainless  
 Nylon Insert

**3/4" Band**  
  
 300 Stainless

**3/4" Bridge**  
  
 300 Stainless

**Trunnion**  
  
 300 Stainless

**Standard T-Bolt**

FIND YOUR PART NUMBER						30050	30051
Nominal Diameter (in)	Nominal Diameter (mm)	Min (in)	Max (in)	Min (mm)	Max (mm)	30050	30051
1.31	33.3	1.25	1.41	31.8	35.7	30050-0131	30051-0131
1.50	38.1	1.34	1.56	34.1	39.7	30050-0150	30051-0150
1.63	41.4	1.47	1.69	37.4	43.0	30050-0163	30051-0163
1.75	44.5	1.59	1.81	40.5	46.0	30050-0175	30051-0175
1.88	47.8	1.72	1.94	43.8	49.3	30050-0188	30051-0188
2.00	50.8	1.84	2.06	46.8	52.4	30050-0200	30051-0200
2.12	53.8	1.96	2.18	49.9	55.4	30050-0212	30051-0212
2.25	57.2	2.09	2.31	53.2	58.7	30050-0225	30051-0225
2.38	60.5	2.22	2.44	56.5	62.0	30050-0238	30051-0238
2.50	63.5	2.34	2.56	59.5	65.1	30050-0250	30051-0250
2.56	65.0	2.33	2.62	59.1	66.6	30050-0256	30051-0256
2.63	66.8	2.40	2.69	60.9	68.4	30050-0263	30051-0263
2.75	69.9	2.52	2.81	63.9	71.4	30050-0275	30051-0275
2.88	73.2	2.65	2.94	67.2	74.7	30050-0288	30051-0288
3.00	76.2	2.77	3.06	70.3	77.8	30050-0300	30051-0300
3.12	79.2	2.87	3.18	72.8	80.8	30050-0312	30051-0312
3.25	82.6	3.02	3.31	76.6	84.1	30050-0325	30051-0325
3.50	88.9	3.27	3.56	83.0	90.5	30050-0350	30051-0350
3.62	91.9	3.39	3.68	86.0	93.5	30050-0362	30051-0362
3.75	95.3	3.52	3.81	89.3	96.8	30050-0375	30051-0375
3.82	97.0	3.59	3.88	91.1	98.6	30050-0382	30051-0382
4.00	101.6	3.77	4.06	95.7	103.2	30050-0400	30051-0400
4.25	108.0	4.02	4.31	102.0	109.5	30050-0425	30051-0425
4.50	114.3	4.27	4.56	108.4	115.9	30050-0450	30051-0450
4.75	120.7	4.52	4.81	114.7	122.2	30050-0475	30051-0475
5.00	127.0	4.77	5.06	121.1	128.6	30050-0500	30051-0500
5.25	133.4	5.02	5.31	127.4	134.9	30050-0525	30051-0525
5.50	139.7	5.27	5.56	133.8	141.3	30050-0550	30051-0550
5.75	146.1	5.52	5.81	140.1	147.6	30050-0575	30051-0575
6.00	152.4	5.77	6.06	146.5	154.0	30050-0600	30051-0600
6.25	158.8	6.02	6.31	152.8	160.3	30050-0625	30051-0625
6.50	165.1	6.27	6.56	159.2	166.7	30050-0650	30051-0650
6.75	171.5	6.52	6.81	165.5	173.0	30050-0675	30051-0675
7.00	177.8	6.77	7.06	171.9	179.4	30050-0700	30051-0700
7.25	184.2	7.02	7.31	178.2	185.7	30050-0725	30051-0725
7.50	190.5	7.27	7.56	184.6	192.1	30050-0750	30051-0750
8.00	203.2	7.77	8.06	197.3	204.8	30050-0800	30051-0800
8.25	209.6	8.02	8.31	203.6	211.1	30050-0825	30051-0825
8.50	215.9	8.27	8.56	210.0	217.5	30050-0850	30051-0850
8.88	225.6	8.65	8.94	219.6	227.1	30050-0888	30051-0888
9.00	228.6	8.77	9.06	222.7	230.2	30050-0900	30051-0900
9.50	241.3	9.27	9.56	235.4	242.9	30050-0950	30051-0950
10.00	254.0	9.77	10.06	248.1	255.6	30050-1000	30051-1000
10.88	276.4	10.65	10.94	270.4	277.9	30050-1088	30051-1088
12.00	304.8	11.77	12.06	298.9	306.4	30050-1200	30051-1200
12.88	327.2	12.65	12.94	321.2	328.7	30050-1288	30051-1288

# SPRING LOADED T-BOLTS

**Spring Loaded T-Bolt** clamps provide uniform sealing pressure for a positive, reliable seal. Designed for use in high vibration and large diameter applications common in heavy trucks, industrial machinery, off-road equipment, agricultural irrigation and machinery. Features a spring-loaded t-bolt assembly, a 3/4" wide stainless steel band and welded construction for reliability.

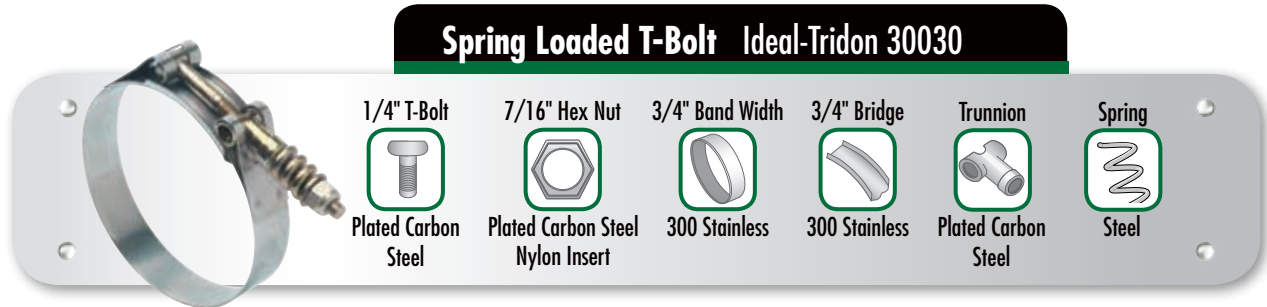

FIND YOUR PART NUMBER					
Size	Min (in)	Max (in)	Min (mm)	Max (mm)	Ideal-Tridon 30030
225	2.250	2.563	57.2	65.1	30030-0225
275	2.750	3.063	69.9	77.8	30030-0275
300	3.000	3.313	76.2	84.1	30030-0300
306	3.063	3.375	77.8	85.7	30030-0306
313	3.125	3.438	79.4	87.3	30030-0313
325	3.250	3.563	82.6	90.5	30030-0325
338	3.375	3.688	85.7	93.7	30030-0338
350	3.500	3.813	88.9	96.8	30030-0350
356	3.563	3.875	90.5	98.4	30030-0356
363	3.625	3.938	92.1	100.0	30030-0363
375	3.750	4.063	95.3	103.2	30030-0375
400	4.000	4.313	101.6	109.5	30030-0400
406	4.063	4.375	103.2	111.1	30030-0406
425	4.250	4.563	108.0	115.9	30030-0425
450	4.500	4.813	114.3	122.2	30030-0450
456	4.563	4.875	115.9	123.8	30030-0456
475	4.750	5.063	120.7	128.6	30030-0475
500	5.000	5.313	127.0	134.9	30030-0500
506	5.063	5.375	128.6	136.5	30030-0506
525	5.250	5.563	133.4	141.3	30030-0525
550	5.500	5.813	139.7	147.6	30030-0550
575	5.750	6.063	146.1	154.0	30030-0575
625	6.250	6.563	158.8	166.7	30030-0625
650	6.500	6.813	165.1	173.0	30030-0650
750	7.500	7.813	190.5	198.4	30030-0750



75 in-lbs (8.5 Nm) for most applications

# V-BANDS

**V-Bands** seal connections for flanged joints. Typical applications include filter housings, turbocharger systems, exhaust systems and industrial applications where a flanged connection is required. V-inserts can be manufactured to OE specifications and are made to order. Additional alloys are available for severe environments.

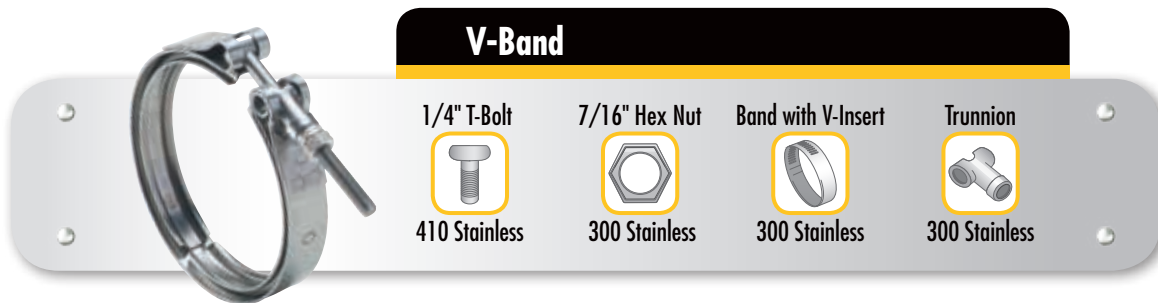

FIND YOUR PART NUMBER												Ideal-Tridon 24000
Nominal Dia. (in)	Nominal Dia. (mm)	Dim "A" (in)	Dim "A" (mm)	Dim "B" (in)	Dim "B" (mm)	Dim "C" (in)	Dim "C" (mm)	Dim "D" (in)	Dim "D" (mm)	Dim "E" (in)	Dim "E" (mm)	
2.88	73.2	0.060	1.52	0.207	5.26	0.281	7.14	0.035	0.89	0.750	19.05	24000-0288
3.21	81.5	0.050	1.27	0.262	6.65	0.141	3.58	0.035	0.89	0.750	19.05	24000-0321
3.82	97.0	0.077	1.96	0.207	5.26	0.281	7.14	0.040	1.02	0.875	22.23	24000-0382
4.06	103.1	0.077	1.96	0.239	6.07	0.281	7.14	0.050	1.27	0.875	22.23	24000-0406
4.13	104.9	0.050	1.27	0.262	6.65	0.141	3.58	0.035	0.89	0.750	19.05	24000-0413
4.19	106.4	0.050	1.27	0.400	10.16	0.281	7.14	0.040	1.02	0.875	22.23	24000-0419
4.25	108.0	0.050	1.27	0.400	10.16	0.281	7.14	0.040	1.02	0.875	22.23	24000-0425
4.50	114.3	0.077	1.96	0.207	5.26	0.281	7.14	0.040	1.02	0.875	22.23	24000-0450
4.61	117.1	0.050	1.27	0.156	3.96	0.281	5.54	0.035	0.89	0.750	19.05	24000-0461
4.75	120.7	0.050	1.27	0.400	10.16	0.281	7.14	0.079	2.01	0.875	22.23	24000-0475
4.81	122.2	0.077	1.96	0.207	5.26	0.281	7.14	0.040	1.02	0.875	22.23	24000-0481
4.94	125.5	0.050	1.27	0.181	4.60	0.281	7.14	0.035	0.89	0.750	19.05	24000-0494
5.25	133.4	0.050	1.27	0.262	6.65	0.141	3.58	0.035	0.89	0.750	19.05	24000-0525
5.81	147.6	0.077	1.96	0.207	5.26	0.281	7.14	0.062	1.57	0.875	22.23	24000-0581
5.88	149.4	0.050	1.27	0.400	10.16	0.281	7.14	0.079	2.01	0.875	22.23	24000-0588
5.92	150.4	0.090	2.29	0.293	7.44	0.296	7.52	0.050	1.27	0.875	22.23	24000-0592

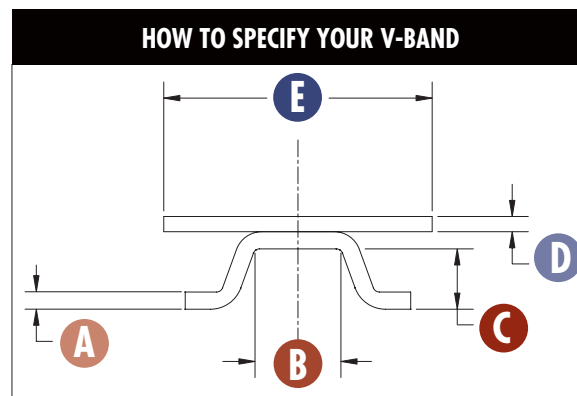

**Specialty V-Bands** for specific OE applications are available, such as the Univee and the Clam Shell. For information on how we can custom engineer a product for your specific application, contact your IDEAL-TRIDON sales representative.



### Univee V-Band

1/4" T-Bolt



420 Stainless

Band with V-Insert



300 Stainless

Trunnion



300 Stainless



### Pressed G, V-Band (Clamshell Design)

M6 Carriage Bolt



300 Stainless

Band with V-Insert



300 Stainless



90 in-lbs (10.2 Nm) for most applications

## Clamp Safety Caps



- Protects installers from cuts and scrapes
- Protects surrounding materials from abrasions and sharp edges
- Provides a clean, professional and finished look for any application
- Installs quickly and easily

### FIND YOUR PART NUMBER

Size (in)	Size (mm)	Qty Per Bag	Master Carton Qty	Part No.
1/2	13	25	40 bags per box*	99999-0012-203
1/2	13	100	10 bags per box*	99999-0012-207
9/16	14	25	40 bags per box*	99999-0916-203
9/16	14	100	10 bags per box*	99999-0916-207

\*Must order in master carton quantities

**Flex-Gear** clamps use a Belleville spring design to eliminate “cold flow” leakage that adjusts with the hose and fitting to maintain constant tension on the connection, eliminating leak paths. Flex-Gear clamps are an excellent choice for fluctuating temperature applications and thermal compensation.

**Features and Benefits:** Belleville spring and clamp construction is built to respond to constant temperature fluctuations. The larger, heavier-gauge, precision-formed springs provide higher rates of band tension and adjustment for a more dependable seal. Inner liner protects against shearing of the hose surfaces.

## Flex-Gear Ideal-Tridon 43



5/16" Hex Head



Plated Carbon Steel

Housing



300 Stainless

Spring



300 Stainless

9/16" Lined Band



300 Stainless

## Flex-Gear Ideal-Tridon 47



5/16" Hex Head



410 Stainless

Housing



300 Stainless

Spring



300 Stainless

9/16" Lined Band



300 Stainless



50 in-lbs (5.6 Nm) for most applications

## Flex-Gear HD Ideal-Tridon 41



3/8" Hex Head



Plated Carbon Steel

Housing



300 Stainless

Spring



300 Stainless

5/8" Lined Band



300 Stainless

## Flex-Gear HD Ideal-Tridon 45

3/8" Hex Head



410 Stainless

Housing



300 Stainless

Spring



300 Stainless

5/8" Lined Band



300 Stainless



75 in-lbs (8.5 Nm) for most applications



**FIND YOUR PART NUMBER**

Size	Min (in)	Max (in)	Min (mm)	Max (mm)	Ideal-Tridon 43	Ideal-Tridon 47
10	9/16	1-1/16	14	27	43010	47010
12	5/8	1-1/4	16	32	43012	47012
16	13/16	1-1/2	21	38	43016	47016
20	13/16	1-3/4	20	44	43020	47020
24	1-1/16	2	27	51	43024	47024
28	1-5/16	2-1/4	33	57	43028	47028
32	1-9/16	2-1/2	40	63	43032	47032
36	1-13/16	2-3/4	46	70	43036	47036
40	2-1/16	3	52	76	43040	47040
44	2-5/16	3-1/4	59	82	43044	47044
48	2-9/16	3-1/2	65	89	43048	47048

**FIND YOUR PART NUMBER**

Size	Min (in)	Max (in)	Min (mm)	Max (mm)	Ideal-Tridon 41	Ideal-Tridon 45
175	1	1-3/4	25	45	41175	45175
212	1-1/4	2-1/8	32	54	41200	45200
262	1-3/4	2-5/8	45	67	41250	45250
312	2-1/4	3-1/8	57	79	41300	45300
362	2-3/4	3-5/8	70	92	41350	45350
412	3-1/4	4-1/8	83	105	41400	45400
462	3-3/4	4-5/8	95	117	41450	45450
512	4-1/4	5-1/8	108	130	41500	45500
562	4-3/4	5-5/8	121	143	41550	45550
612	5-1/4	6-1/8	133	155	41600	45600
662	5-3/4	6-5/8	146	168	41650	45650
712	6-1/4	7-1/8	159	181	41700	45700
762	6-3/4	7-5/8	172	193	41750	45750
812	7-1/4	8-1/8	184	206	41800	45800
862	7-3/4	8-5/8	197	219	41850	45850
912	8-1/4	9-1/8	210	232	41900	45900



## Did you know...

IDEAL-TRIDON offers a next generation, lighter smart clamp that can be used instead of heavier Flex-Gear clamps? If weight savings and compact design are your key needs, review our lineup of SmartSeal clamps on page 8. SmartSeal clamps represent the pinnacle in joint sealing technology, and their ultra compact profile is perfect for high vibration and thermal cycling applications.

IDEAL-TRIDON offers a wide variety of display options to get your clamp stock in front of customers. Choose from three pre-assembled wire racks and display your clamps right on the counter. Or, attach the pegs and turn it into a shelf unit.

## 130 Piece Clamp Profit Center



### 130-Piece Clamp Profit Center

Holds 130 clamps with multiple assortment options.

15" H x 14" W x 5" D

### FIND YOUR PART NUMBER

#### SIZES AND QUANTITIES PER PACKAGE

Description	Micro 4	Micro 6	Size 10	Size 12	Size 20	Size 28	Size 36	Part No.
130 Piece Rack Only	–	–	–	–	–	–	–	2671001
Automotive Assortment + Rack	20	20	10	20	20	20	20	99903-0520-051
Automotive Assortment Clamps Only	20	20	10	20	20	20	20	99902-0520-051
Industrial/Automotive Assortment + Rack	20	20	10	20	20	20	20	99903-0570-051
Industrial/Automotive Assortment Clamps Only	20	20	10	20	20	20	20	99902-0570-051
Hardware Assortment + Rack	20	20	10	20	20	20	20	99903-0671-053
Hardware Assortment Clamps Only	20	20	10	20	20	20	20	99902-0671-053

## Clamp Onto Sales with Clamp Profit Centers

- IDEAL-TRIDON exclusive
- Eye-catching designs
- Tough with sturdy metal construction and durable styrene signs
- Visible merchandise promotes efficient, organized stock control
- Pre-assembled
- Countertop or peg board display



### Large Clamp Rack Part No: 2674001

Holds 250 clamps with multiple assortment options.



### Small Clamp Rack Part No: 2673001

Holds 130 clamps with multiple assortment options.

## Clamp Shaped Rack Assortment Options

67-4	67-1	57-0	68-0	50-0
				
5/16" Hex Head 	5/16" Hex Head 	5/16" Hex Head 	5/16" Hex Head 	5/16" Hex Head 
300 Stainless	410 Stainless	Plated Carbon Steel	410 Stainless	Plated Carbon Steel
UPC Shield 	Housing 	Housing 	Housing 	Housing 
300 Stainless	200 Stainless	200 Stainless	200 Stainless	200 Stainless
1/2" Band Width 	1/2" Band Width 	1/2" Band Width 	9/16" Band Width 	9/16" Band Width 
300 Stainless	200 Stainless	200 Stainless	200 Stainless	200 Stainless
1/2" Hy-Gear	1/2" Hy-Gear	1/2" Hy-Gear	9/16" Hy-Gear	9/16" Hy-Gear

### SIZES AND QUANTITIES PER PACKAGE

	Micro 4	Micro 6	Size 10	Size 12	Size 20	Size 28	Size 36
<b>Small Clamp Rack + 250 Pieces</b>	40	40	40	40	30	30	30
<b>Large Clamp Rack + 450 Pieces</b>	70	70	60	60	70	60	60
<b>Large Clamp Rack + 600 Pieces</b>	100	100	80	80	80	80	80

### FIND YOUR PART NUMBER

	Small Clamp Rack Only: 2673001		Large Clamp Rack Only: 2674001		
	67-4	67-1	57-0	68-0	50-0
<b>250 Pieces + Small Rack</b>	99903-1674-051	99903-1671-051	99903-1570-051	99903-1680-051	99903-1500-051
<b>450 Pieces + Large Rack</b>	99903-2674-051	99903-2671-051	99903-2570-051	99903-2680-051	99903-2500-051
<b>600 Pieces + Large Rack</b>	99903-3674-051	99903-3671-051	99903-3570-051	99903-3680-051	99903-3500-051
<b>250 Clamps Only</b>	99902-1674-051	99902-1671-051	99902-1570-051	99902-1680-051	99902-1500-051
<b>450 Clamps Only</b>	99902-2674-051	99902-2671-051	99902-2570-051	99902-2680-051	99902-2500-051
<b>600 Clamps Only</b>	99902-3674-051	99902-3671-051	99902-3570-051	99902-3680-051	99902-3500-051

\*All assortments are available with individually barcoded clamps. Replace 051 in the part no. with 053.

## SmartSeal® Profit Center Kit

### Includes

- **SmartSeal Clamp Rack:** holds 50 clamps and comes with peg-board hooks
- **SmartSeal Clamps:** 50 clamps in five 10-piece subpack boxes in sizes 20, 24, 28, 36, and 40
- **SmartSeal Blister Assortment with clip strip:** comes with 10 SmartSeal blister packs, two each of sizes 20, 24, 28, 36, and 40



17-3/8" H x 16" W x 6-13/16" D  
Part No: 2688001

### FIND YOUR PART NUMBER

SmartSeal Clamp Rack Only	2688001
SmartSeal Clamps Only: 50 pcs	99902-7215-051*
SmartSeal Clamp Rack + Clamps	99903-7215-051*
SmartSeal Profit Center Kit: Rack + Clamps + Blister Assortment with Strip Clip	99904-7215-051*
Blister Assortment with Strip Clip	99904-7215-058

\*Available with individually barcoded clamps. Replace 051 in the part no. with 053



Sub Pack Boxes



Blister Packaging

## 25-Piece Contractor Pack Bags



- All Stainless Steel
- Uniform Plumber Code Certified (1/2" Hy-Gear Clamps)
- Durable Resealable Bag

### FIND YOUR PART NUMBER

Size	Min (in)	Max (in)	Min (mm)	Max (mm)	Description	Qty	Part No.
4	5/16	5/8	6	16	Micro-Gear®	25	6260450
6	5/16	7/8	8	22	Micro-Gear®	25	6260650
6	3/8	7/8	10	22	1/2" Hy-Gear®	25	6706550
8	7/16	1	11	25	1/2" Hy-Gear®	25	6708550
10	1/2	1-1/16	13	27	1/2" Hy-Gear®	25	6710550
12	1/2	1-1/4	13	32	1/2" Hy-Gear®	25	6712550
16	11/16	1-1/2	18	38	1/2" Hy-Gear®	25	6716550
20	3/4	1-3/4	19	44	1/2" Hy-Gear®	25	6720550
24	1	2	25	51	1/2" Hy-Gear®	25	6724550
28	1-1/4	2-1/4	32	57	1/2" Hy-Gear®	25	6728550
36	3/4	2-3/4	19	70	1/2" Hy-Gear®	25	6736550
48	1-1/2	3-1/2	38	89	1/2" Hy-Gear®	25	6748550
64	2-1/2	4-1/2	64	114	1/2" Hy-Gear®	25	6764550

## 10-Piece Assortment Bags



Part No. **671755J**

Master Carton Qty. of 10

- Resealable Bags of 10-Piece
- Assorted Stainless Steel Clamps
- Clamping range 1/4" to 2-3/4"
- Uniform Plumber Code Certified (1/2" Hy-Gear Clamps)

### QUANTITIES PER BAG

Size	Qty
Micro-Gear® 4	2
1/2" Hy-Gear® 6	1
1/2" Hy-Gear® 12	3
1/2" Hy-Gear® 20	3
1/2" Hy-Gear® 36	1

## Blister Pack Product Line

### ADDING VALUE TO YOUR BUSINESS

IDEAL-TRIDON® offers an extensive blister pack product line. Blister packs offer ease of visibility, attractive packaging and convenient quantities. Various bandwidths, material specifications, size options and assortments are available. Popular blister pack products add value by offering customers a quick and easy way to locate the clamp they need and purchase the smaller quantity that they are looking for.





# MERCHANDISERS & PACKAGING

## FIND YOUR PART NUMBER

Description	Pack Qty	SAE Size	Min (in)	Max (in)	Min (mm)	Max (mm)	Band Mat.	Housing Mat.	Screw Mat.	Band width	Part Number
SmartSeal® 37215 Series	2	16	1-3/32	1-9/32	28	33	300 SS	300 SS	300 SS	1/2	37215-0016-058
SmartSeal® 37215 Series	2	20	1-1/8	1-9/16	29	40	300 SS	300 SS	300 SS	1/2	37215-0020-058
SmartSeal® 37215 Series	2	24	1-1/2	1-13/16	38	46	300 SS	300 SS	300 SS	1/2	37215-0024-058
SmartSeal® 37215 Series	2	28	1-3/4	2-1/16	43	52	300 SS	300 SS	300 SS	1/2	37215-0028-058
SmartSeal® 37215 Series	2	36	2-1/8	2-9/16	53	65	300 SS	300 SS	300 SS	1/2	37215-0036-058
SmartSeal® 37215 Series	2	40	2-5/16	2-13/16	58	71	300 SS	300 SS	300 SS	1/2	37215-0040-058
Emergency Clamp Kit Assortment 62M Series and 50 Series	6	4, 12, 28 (2 each)	1/4	2-1/4	6	57	200 SS	200 SS	PCS	5/16, 9/16	5004058
Hy-Gear® 50 Series Clamps	2	12	1/2	1-1/4	13	32	200 SS	200 SS	PCS	9/16	5012058
Hy-Gear® 50 Series Clamps	2	20	3/4	1-3/4	19	44	200 SS	200 SS	PCS	9/16	5020058
Hy-Gear® 50 Series Clamps	2	28	1-1/4	2-1/4	32	57	200 SS	200 SS	PCS	9/16	5028058
Hy-Gear® 50 Series Clamps	2	36	3/4	2-3/4	19	70	200 SS	200 SS	PCS	9/16	5036058
Hy-Gear® 50 Series Clamps	2	48	1-1/2	3-1/2	38	89	200 SS	200 SS	PCS	9/16	5048058
Micro-Gear® 52M Series Clamps	4	4	1/4	5/8	6	16	200 SS	PCS	PCS	5/16	5202058
Micro-Gear® 52M Series Clamps	4	6	5/16	7/8	8	22	200 SS	PCS	PCS	5/16	5203058
52 Series Clamps Assortment	6	4, 12, 28 (2 each)	1/4	2-1/4	6	57	200 SS	PCS	PCS	5/16, 1/2	5204058
52 Series Clamps	2	12	1/2	1-1/4	13	32	200 SS	PCS	PCS	1/2	5212058
52 Series Clamps	2	20	3/4	1-3/4	19	44	200 SS	PCS	PCS	1/2	5220058
52 Series Clamps	2	28	1-1/4	2-1/4	32	57	200 SS	PCS	PCS	1/2	5228058
52 Series Clamps	2	36	1-3/4	2-3/4	44	70	200 SS	PCS	PCS	1/2	5236058
52 Series Clamps	2	48	2-1/2	3-1/2	64	89	200 SS	PCS	SS	1/2	5248058
52 Series Clamps	2	64	2-1/2	4-1/2	64	114	200 SS	PCS	PCS	1/2	5264058
Hy-Gear® 57 Series Clamps	2	12	1/2	1-1/4	13	32	200 SS	200 SS	PCS	1/2	5512058
Hy-Gear® 57 Series Clamps	2	20	3/4	1-3/4	19	44	200 SS	200 SS	PCS	1/2	5520058
Hy-Gear® 57 Series Clamps	2	28	1-1/4	2-1/4	32	57	200 SS	200 SS	PCS	1/2	5528058
Hy-Gear® 57 Series Clamps	2	36	3/4	2-3/4	19	70	200 SS	200 SS	PCS	1/2	5536058
Micro-Gear® 62P Series Clamps	4	4	5/16	5/8	8	16	300 SS	300 SS	PCS	5/16	6204058
Micro-Gear® 62P Series Clamps	4	6	5/16	7/8	8	22	300 SS	300 SS	PCS	5/16	6206058
FuelInjection 52F Series Clamps	4	13	7/16	1/2	11	13	PCS	—	PCS	9 mm	52F1358
FuelInjection 52F Series Clamps	4	15	1/2	9/16	13	15	PCS	—	PCS	9 mm	52F1558
FuelInjection 52F Series Clamps	4	16	9/16	5/8	14	16	PCS	—	PCS	9 mm	52F1658
Turn-Key® 5Y Series Clamps Assortment	6	4, 6, 12, 20, 28, 36 (1 each)	5/16	2-3/4	8	70	200 SS	300 SS	PCS	5/16, 1/2	5Y00158
Turn-Key® 5Y Series Clamps	2	12	1/2	1-1/4	13	32	200 SS	300 SS	PCS	1/2	5Y01258
Turn-Key® 5Y Series Clamps	2	20	3/4	1-3/4	19	44	200 SS	300 SS	PCS	1/2	5Y02058
Turn-Key® 5Y Series Clamps	2	28	1-1/4	2-1/4	32	57	200 SS	300 SS	PCS	1/2	5Y02858
Turn-Key® 5Y Series Clamps	2	36	1-3/4	2-3/4	44	70	200 SS	300 SS	PCS	1/2	5Y03658
Turn-Key® 5Y Series Clamps	2	48	2-1/2	3-1/2	64	89	200 SS	300 SS	PCS	1/2	5Y04858
Turn-Key® 5Y Series Clamps	2	64	2-1/2	4-1/2	64	114	200 SS	300 SS	PCS	1/2	5Y06458
Turn-Key® 6Y Series Clamps Assortment	4	4, 6 (2 each)	5/16	7/8	8	22	200 SS	300 SS	PCS	5/16	6Y00458

SS = Stainless Steel  
PCS = Plated Carbon Steel



# PRODUCT CROSS REFERENCE GUIDE

Product	Ideal-Tridon	Tridon	Product Description	NORMA Breeze RG Ray	Murray	Dixon	Catalog Page
Turn-Key®	5Y	-	1/2" Band, Consumer Product Partial SS Clamps - No Tools Required	-	T-SS	HS-Y	25
Pow'r-Gear®	6L	M843	5/8" Band, High Performance Lined All SS Worm Drive Clamps	HTM-L	-	-	28
Pow'r-Gear®	6M	-	5/8" Band, High Performance Lined All 300 SS Marine Clamps	HTS-L	-	-	28
Pow'r-Gear®	6P	-	5/8" Band, High Performance All 300 SS Marine Worm Drive Clamps	HTM-SP	-	-	28
Pow'r-Gear®	6X	-	5/8" Band, High Performance Wide Range All SS Worm Drive Clamps	HP	-	HP	28
Pow'r-Gear®	60	M850	5/8" Band, High Performance All SS Worm Drive Clamps	HTM	-	HTM	28
Flex-Gear HD®	41	-	5/8" Band, Constant Tension Partial SS Clamps	CT-L	-	CT-L	36
Flex-Gear®	43	-	9/16" Band, Constant Tension Partial SS Clamps	CT-92	-	-	36
Flex-Gear HD®	45	-	5/8" Band, Constant Tension All SS Clamps	CT-L SS	-	-	36
Flex-Gear®	47	-	9/16" Band, Constant Tension All SS Clamps	CT-94	-	-	36
Surelock	48	-	9/16" Band, Quick Engage Clamps, 300 SS Marine	600	-	-	21
Surelock	49	-	9/16" Band, Quick Engage Clamps, 316 SS Marine	616	-	-	21
9/16" Hy-Gear®	50-0	150	9/16" Band, Partial SS Clamps	100	-	HS**	14
1/2" Hy-Gear®	52-0	600-603	1/2" Band, Partial SS Clamps				12
Lined	53-0	613/ET	1/2" Band, Lined Partial SS Clamps	92	48	DL	26
Combo-Hex®	54-0	-	9/16" Band, Special 3/8" Hex Screw Partial SS Clamps	-	-	-	20
Snaplock®	56-0	-	9/16" Band, Quick Release 5/16" Hex Screw Partial Clamps	-	-	LS	22
1/2" Hy-Gear®	57-0	611/HS	1/2" Band, General Purpose Partial SS Clamps	62	H	HS**	12
Snaplock®	58-0	58-0/LAS	9/16" Band, Quick Release 3/8" Hex Screw All SS Clamps	-	-	LSS	22
Wraplock®	59-0	-	1/2" Band, Specialty Clamps	-	-	-	24
Pinch	61-0	-	Single Ear Pinch All 300 SS Clamps		KS		19
9/16" Hy-Gear®	64-0	-	9/16" Band, Special 3/8" Hex Screw All SS Clamps	200	-	-	14
9/16" Hy-Gear®	68-0	-	9/16" Band, General Purpose All SS Clamps	200	-	-	14
Lax-On®	69-0	-	1/2" Band, Special Purpose All 300 Marine Clamps	-	-	-	24
Snaplock®	500	500/LS	1/2" Band, Quick Release Partial SS Clamps	-	-	LS	22
Snaplock®	550	550/LSS	1/2" Band, Quick Release All SS Clamps	QR	-	LSS	22
Fuel Injection	52F	905/FI	9 mm Band, Special Fuel Injection Clamps	FI	-	-	11
Micro-Gear®	52M	300	5/16" Band, Partial SS Clamps				10
Micro-Gear®	359	359	5/16" Band, All 316 SS Marine Clamps	38	-	-	10
Micro-Gear®	62M	345/MAH/MAS	5/16" Band, All SS Clamps	37/67	MMF-SS	MAH	10
Micro-Gear®	62P	325/MH	5/16" Band, Partial SS Clamps	35	MM	MH	10
Turn-Key®	6Y	-	5/16" Band, Consumer Product Partial SS Clamps - No Tools Required			MH	25
Military	632	632	1/2" Band, Military Spec All SS Clamps	MS	-	-	20
9/16" Hy-Gear®	63-4	-	9/16" Band, All 300 SS Marine Clamps	300	-	HSS**	14
Lined	65-E	615*	9/16" Band, Lined Clamps, All 300 SS Clamps	94*	48	-	26
1/2" Hy-Gear®	67-1	625/HAS	1/2" Band, General Purpose All SS Clamps	64	H-SS	-	12
1/2" Hy-Gear®	67-4	620P	1/2" Band, All 300 SS Marine Clamps	63	HF-SS	HSS**	12
1/2" Hy-Gear®	67-5	620	1/2" Band, All 200 SS Clamps				12
1/2" Hy-Gear®	67-6	665	1/2" Band, All 316 SS Marine Clamps	-	HDL	MGC	12
Lined	67M	-	1/2" Band, All 316 SS Lined Marine Clamps	96	-	-	26
T-Bolt	30010	813	3/4" Band, T-Bolt Partial SS Clamps	B9200	TB	-	30
T-Bolt	30011	811	3/4" Band, T-Bolt All 300 SS Clamps	B9300	TB-SS	-	30
T-Bolt	30020	814	3/4" Band, T-Bolt w/ Bridge Partial SS Clamps	B9222	-	-	30
T-Bolt	30021	810	3/4" Band, T-Bolt w/ Bridge All 300 SS Clamps	-	-	-	30
T-Bolt	30030	819	3/4" Band, Spring Loaded Partial SS T-Bolt Clamps	B9226	TB-L	-	33
T-Bolt	30050	-	3/4" Band, Nominal Sized Partial SS Clamps			TBC	32
T-Bolt	30051	-	3/4" Band, Nominal Sized All 300 SS Clamps			STBC	32
WaveSeal <sup>360</sup> ®	36003	36013	9/16" Band, 360 Degree Seal Self-Adjusting Constant Pressure All SS Clamps	-	-	WSS	8
SmartSeal®	37215	-	1/2" Band, 360 Degree Seal Self-Adjusting Constant Pressure All SS Clamps	-	DB	-	8
SmartSeal® HD	38215	38210	5/8" Band, 360 Degree Seal Self-Adjusting Constant Pressure All SS Clamps	-	-	-	8
Non-Perforated	53302	53312	9 mm Band, W2 Non-Perforated (Embossed) W2 Partial SS Clamps	Torro W2**	EB9	-	16
Non-Perforated	53303	53313	9 mm Band, W3 Non-Perforated (Embossed) W3 All 430 SS Clamps	Torro W3**	-	-	16
Non-Perforated	53304	53314	9 mm Band, W4 Non-Perforated (Embossed) W4 All 304 SS Clamps	Torro W4**	-	EB9	16
Non-Perforated	53305	53315	9 mm Band, W5 Non-Perforated (Embossed) W5 All 316 SS Clamps	Torro W5**	-	EBL9	16
Non-Perforated	53402	53412	12 mm Band, W2 Non-Perforated (Embossed) W2 Partial SS Clamps	Torro W2**	EB12	-	16
Non-Perforated	53403	53413	12 mm Band, W3 Non-Perforated (Embossed) W3 All 430 SS Clamps	Torro W3**	-	-	16
Non-Perforated	53404	53414	12 mm Band, W4 Non-Perforated (Embossed) W4 All 304 SS Clamps	Torro W4**	-	EB12	16
Non-Perforated	53405	53415	12 mm Band, W5 Non-Perforated (Embossed) W5 All 316 SS Clamps	Torro W5**	-	EBL12	16

\*Comparable Product  
\*\*Check Bandwidth

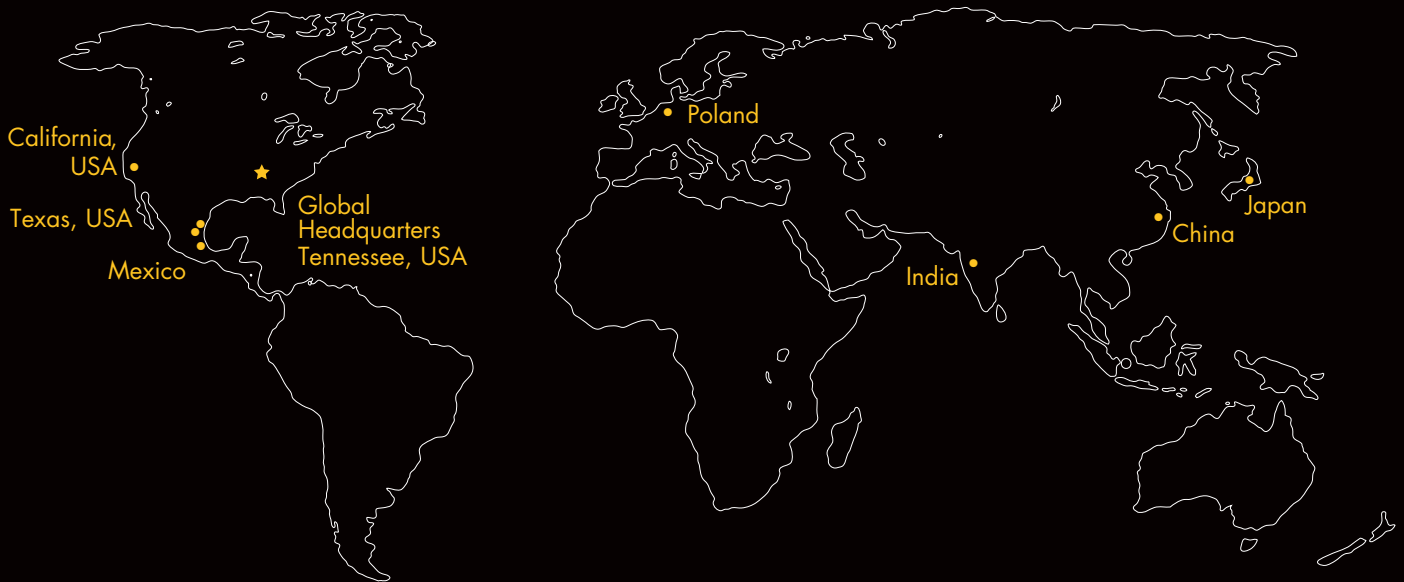

**IDEALTRIDON.COM | PROVEN DESIGNS, BILLIONS OF TIMES**

**GLOBAL HEADQUARTERS**

**8100 TRIDON DRIVE SMYRNA, TN 37167 USA**

**800.251.3220 | 615.459.5800**

**USA | MEXICO | CHINA | JAPAN | POLAND | INDIA**



**PLEASE RECYCLE**

© 2016 Ideal Clamp Products, Inc. — Part No. 99999-1001-099 JAN 2017